

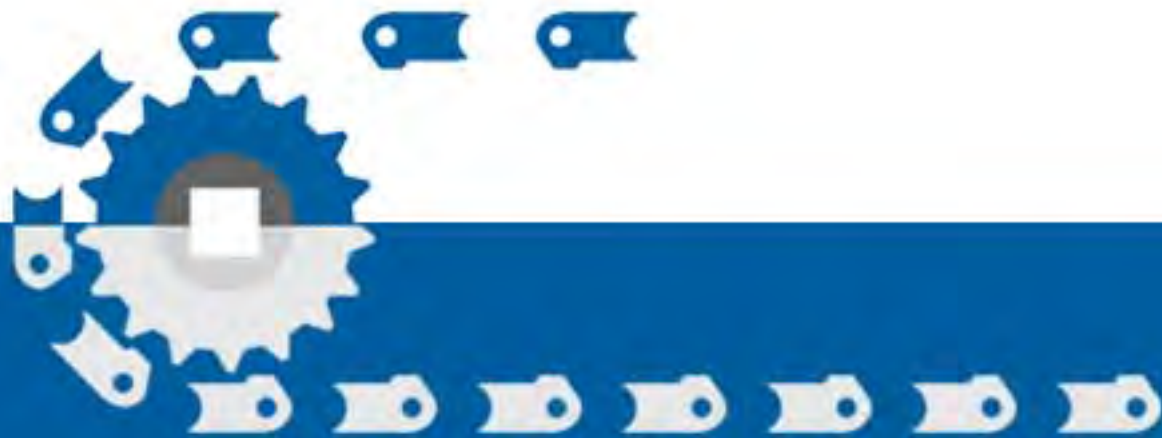

Table Top

Plastic Modular

CHAIN & BELT

Products Manual Book



YONGLI - Engineer your movement

Contents

| | | |
|---|---------|---|
| 1 | Profile | 3 |
|---|---------|---|

| | | |
|---|-----------------|--------|
| 2 | Table top chain | 4 - 19 |
|---|-----------------|--------|

| | | |
|---|--------------|---------|
| 3 | Modular belt | 20 - 69 |
|---|--------------|---------|

| | | |
|---|-----------|---------|
| 4 | Component | 70 - 84 |
|---|-----------|---------|

— Engineer Your Movement



YONGLINK -A member of YongLi Group

Whatever YongLi changes, we will guard our values:

- Close communication with customers.
- Listening to the wishes and demands of customers.
- Providing customized solutions.



History:









- 1989, YongLi plastic-rubber industry&commerce Co.,Ltd was set up.
- 2001, YongLi Industrial Belting Co.Ltd was set up and started to manufacture light weight conveyor belts.
- 2005, YongLi Europe B.V. was set up in the Netherlands.
- 2006, YongLi set up the second manufacturing plant in Chongming,Shanghai.
- 2009, YongLi International Holding B.V. was set up in The Netherlands.
- 2010, YongLi set up a research and development department in the Netherlands.
- 2011.6, YongLi went public in Shenzhen Stock Exchange.
- 2013.2, YongLi Korea Co.,LTD was set up in Seoul, Korea.
- 2013.12, YongLi Sp.z.o.o. was set up in Czersk, Poland.
- 2015.1, YongLi America LLC was set up in Indiana,USA.
- 2015.3, YongLi Deutschland GmbH was set up in Europe.
- 2015.9, YongLi Österreich GmbH was set up in Europe.
- 2016, YongLink was set up

Main industries:







- Beverages
- Fruit & Vegetable
- Poultry
- Dairy
- Pharmacy
- Tyre
- Logistic
- Corrugated paper

Table top chain

Normal chain

| | | | |
|---|---|---|---|
|  <p>LF820K325 Page: 5</p> |  <p>LF820K450 Page: 6</p> |  <p>LF880TK325 Page: 7</p> |  <p>LF880TK450 Page: 8</p> |
|  <p>LF821K1200 Page: 9</p> |  <p>FTM2540TK326 Page: 10</p> |  <p>LF3810TK282 Page: 11</p> |  <p>LBP882TK1000 Page: 12</p> |

Magnetic chain

| | | | |
|--|---|--|---|
|  <p>SF2540TK200 Page: 13</p> |  <p>SF2540TK276 Page: 14</p> |  <p>SF2540TK405 Page: 15</p> |  <p>SF3350TK326 Page: 16</p> |
|  <p>SG3350TK326 Page: 17</p> |  <p>SF3550TK405 Page: 18</p> |  <p>SG3550TK405 Page: 19</p> | |

Type: Table top chain

Code : LF820K325

| Specification | |
|---------------------------|-----------|
| Pitch P | 38.1 mm |
| Thickness T | 4.0 mm |
| Pin Dia. D | 6.3 mm |
| Weight | 0.85 kg/m |
| Material | POM |
| Color | Tan |
| Open area | - |
| Permissible tensile force | 1600 N/m |
| Pin material | 201(304) |
| Counter flection | 40.0 mm |
| Running radius | - |
| Characteristic | FDA |
| Temperature | -40~93 °C |



Belt Width=82.6 mm

| | | | | | | | | | |
|--|--|--|--|--|--|--|--|--|--|
| | | | | | | | | | |
| | | | | | | | | | |
| | | | | | | | | | |
| | | | | | | | | | |

Sprocket

| | |
|------------------|------------------------|
| Tooth Z | 21 tooth drive / idler |
| Bore S | 40.0 mm |
| Diameter Ø | 129.0/131.0 mm |
| Tooth width d | 46.0/- mm |
| Sprocket width D | 53.0/57.0 mm |
| Material | PA |
| Color | Black |

Application

Food, beverages, pharmacy, cosmetics and other industrial that handle small-medium size products

Type: Table top chain

Code : LF820K450

| Specification | |
|---------------------------|-----------|
| Pitch P | 38.1 mm |
| Thickness T | 4.0 mm |
| Pin Dia. D | 6.3 mm |
| Weight | 1.03 kg/m |
| Material | POM |
| Color | Tan |
| Open area | - |
| Permissible tensile force | 1600 N/m |
| Pin material | 201(304) |
| Counter flection | 40.0 mm |
| Running radius | - |
| Characteristic | FDA |
| Temperature | -40~93 °C |



Belt Width=114.3 mm

| | | | | | | | | | |
|--|--|--|--|--|--|--|--|--|--|
| | | | | | | | | | |
| | | | | | | | | | |
| | | | | | | | | | |
| | | | | | | | | | |

Sprocket

| | |
|------------------|------------------------|
| Tooth Z | 21 tooth drive / idler |
| Bore S | 40.0 mm |
| Diameter Ø | 129.0/131.0 mm |
| Tooth width d | 46.0/- mm |
| Sprocket width D | 53.0/57.0 mm |
| Material | PA |
| Color | Black |

Application

Food, beverages, pharmacy, cosmetics and other industrial that handle small-medium size products

Type: Side flexing table top chain

Code : LF880TK325

| Specification | |
|---------------------------|-----------|
| Pitch P | 38.1mm |
| Thickness T | 4.0 mm |
| Pin Dia. D | 6.3 mm |
| Weight | 0.94 kg/m |
| Material | POM |
| Color | Tan |
| Open area | - |
| Permissible tensile force | 2000 N/m |
| Pin material | 201(304) |
| Counter flexion | 40.0 mm |
| Running radius | 500.0 mm |
| Characteristic | FDA |
| Temperature | -40~93 °C |



Belt Width=82.6 mm

| | | | | | | | | | |
|--|--|--|--|--|--|--|--|--|--|
| | | | | | | | | | |
| | | | | | | | | | |
| | | | | | | | | | |
| | | | | | | | | | |

Sprocket

| | |
|------------------|----------|
| Tooth Z | 10 |
| Bore S | 40.0 mm |
| Diameter Ø | 122.4 mm |
| Tooth width d | 15.0 mm |
| Sprocket width D | 50.0 mm |
| Material | PA |
| Color | Black |

Application

Food, beverages, pharmacy, cosmetics, tobacco and other industrial that handle small-medium size products

Type: Side flexing table top chain

Code : LF880TK450

| Specification | |
|---------------------------|-----------|
| Pitch P | 38.1mm |
| Thickness T | 4.0 mm |
| Pin Dia. D | 6.3 mm |
| Weight | 1.08 kg/m |
| Material | POM |
| Color | Tan |
| Open area | - |
| Permissible tensile force | 2000 N/m |
| Pin material | 201(304) |
| Counter flection | 40.0 mm |
| Running radius | 610.0 mm |
| Characteristic | FDA |
| Temperature | -40~93 °C |



Belt Width=114.3 mm

| | | | | | | | | | |
|--|--|--|--|--|--|--|--|--|--|
| | | | | | | | | | |
| | | | | | | | | | |
| | | | | | | | | | |
| | | | | | | | | | |

Sprocket

| | |
|------------------|----------|
| Tooth Z | 10 |
| Bore S | 40.0 mm |
| Diameter Ø | 122.4 mm |
| Tooth width d | 15.0 mm |
| Sprocket width D | 50.0 mm |
| Material | PA |
| Color | Black |

Application

Food, beverages, pharmacy, cosmetics and other industrial that handle small-medium size products

Type: Table top chain

Code : LF821K1200

| Specification | |
|---------------------------|-----------|
| Pitch P | 38.1 mm |
| Thickness T | 5.1 mm |
| Pin Dia. D | 6.5 mm |
| Weight | 3.35 kg/m |
| Material | POM |
| Color | Tan |
| Open area | - |
| Permissible tensile force | 2800 N/m |
| Pin material | 201(304) |
| Counter flexion | 45.0 mm |
| Running radius | - |
| Characteristic | FDA |
| Temperature | -40~93 °C |



Belt Width=304.8 mm

| | | | | | | | | | |
|--|--|--|--|--|--|--|--|--|--|
| | | | | | | | | | |
| | | | | | | | | | |
| | | | | | | | | | |
| | | | | | | | | | |

Sprocket

| | |
|------------------|------------------------|
| Tooth Z | 21 tooth drive / idler |
| Bore S | 40.0 mm |
| Diameter Ø | 130.0/132.2 mm |
| Tooth width d | 80.0/- mm |
| Sprocket width D | 90.0/160.0 mm |
| Material | PA |
| Color | Natural |

Application

Food, beverages and other industrial that handle small-medium size products

Type: Side flexing table top chain

Code : FTM2540TK326

| Specification | |
|---------------------------|-------------------|
| Pitch P | 25.4 mm |
| Thickness T | 8.7 mm |
| Pin Dia. D | 8.0 mm |
| Weight | 1.66 kg/m |
| Material | POM |
| Color | Dark green |
| Open area | - |
| Permissible tensile force | 2200 N/m |
| Pin material | 45#Nickel plating |
| Counter flection | 130.0 mm |
| Running radius | 500.0mm |
| Characteristic | FDA |
| Temperature | -40~93 °C |



Belt Width=82.8 mm

| | | | | | | | | | |
|--|--|--|--|--|--|--|--|--|--|
| | | | | | | | | | |
| | | | | | | | | | |
| | | | | | | | | | |
| | | | | | | | | | |

Sprocket

| | |
|------------------|---------|
| Tooth Z | 18 |
| Bore S | 40.0 mm |
| Diameter Ø | 146 mm |
| Tooth width d | 11.0 mm |
| Sprocket width D | 50.0 mm |
| Material | PA |
| Color | Black |

Application

Food, beverages and other industrial that handle small-medium size products

Type: Table top chain

Code : LF3810TK282

| Specification | |
|---------------------------|----------|
| Pitch P | 38.1mm |
| Thickness T | 12.7 mm |
| Pin Dia. D | 6.3 mm |
| Weight | 1.2 kg/m |
| Material | POM |
| Color | Tan |
| Open area | - |
| Permissible tensile force | 2000 N/m |
| Pin material | 304 |
| Counter flection | 40.0 mm |
| Running radius | - |
| Characteristic | FDA |
| Temperature | -40~93°C |



Belt Width=71.6 mm

| | | | | | | | | | |
|--|--|--|--|--|--|--|--|--|--|
| | | | | | | | | | |
| | | | | | | | | | |
| | | | | | | | | | |
| | | | | | | | | | |

Sprocket

| | |
|------------------|---|
| Tooth Z | - |
| Bore S | - |
| Diameter Ø | - |
| Tooth width d | - |
| Sprocket width D | - |
| Material | - |
| Color | - |

Application

Tobacco and other industrial that handle small-medium size products

Type: Low back pressure table top chain

Code : LBP882TK1000

| Specification | |
|---------------------------|-------------|
| Pitch P | 38.1 mm |
| Thickness T | 19.05 mm |
| Pin Dia. D | 8.6 mm |
| Weight | 5.7 kg/m |
| Material | POM |
| Color | Tan |
| Open area | - |
| Permissible tensile force | 2780 N/m |
| Pin material | 201 (304) |
| Counter flection | 228.0 mm |
| Running radius | 610.0 mm |
| Characteristic | FDA |
| Temperature | -40~93 °C |

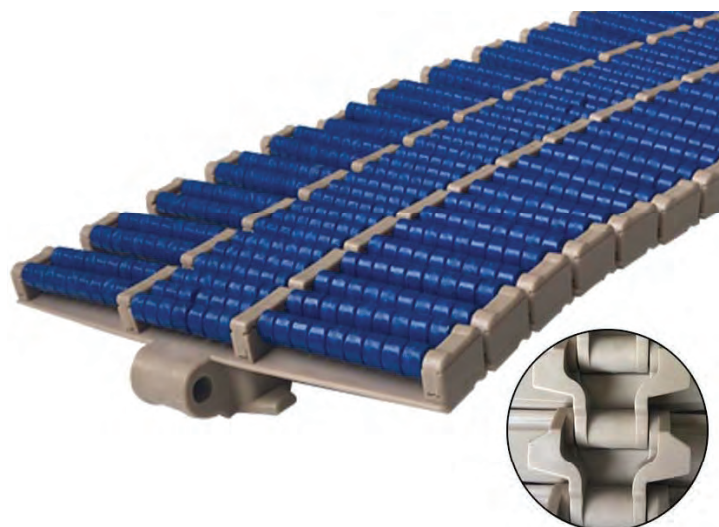

Belt Width=254 mm

| | | | | | | | | | |
|--|--|--|--|--|--|--|--|--|--|
| | | | | | | | | | |
| | | | | | | | | | |
| | | | | | | | | | |
| | | | | | | | | | |

Sprocket

| | |
|------------------|----------|
| Tooth Z | 12 |
| Bore R | 40.0 mm |
| Diameter Ø | 149.0 mm |
| Tooth width d | 22.0 mm |
| Sprocket width D | 41.0 mm |
| Material | PA |
| Color | Black |

Application

Food, beverages and other industrial that handle small-medium size products

Type: Flexible table top chain

Code : SF2540TK200

| Specification | |
|---------------------------|----------|
| Pitch P | 25.4 mm |
| Thickness T | 6.0 mm |
| Pin Dia. D | 4.0 mm |
| Weight | 0.8 kg/m |
| Material | POM |
| Color | Natural |
| Open area | - |
| Permissible tensile force | 1000 N/m |
| Pin material | 304 |
| Counter flection | 125.0 mm |
| Running radius | 250.0 mm |
| Characteristic | FDA |
| Temperature | -40~93°C |



Belt Width=50.8 mm

| | | | | | | | | | |
|--|--|--|--|--|--|--|--|--|--|
| | | | | | | | | | |
| | | | | | | | | | |
| | | | | | | | | | |
| | | | | | | | | | |

Sprocket

| | |
|------------------|---|
| Tooth Z | - |
| Bore S | - |
| Diameter Ø | - |
| Tooth width d | - |
| Sprocket width D | - |
| Material | - |
| Color | - |

Application

Tobacco and other industrial that handle small-medium size products

Type: Side flexing table top chain

Code : SF2540TK276

Specification

| | |
|---------------------------|----------|
| Pitch P | 25.4 mm |
| Thickness T | 4.1 mm |
| Pin Dia. D | 5.3 mm |
| Weight | 1.3 kg/m |
| Material | POM |
| Color | White |
| Open area | - |
| Permissible tensile force | 1400 N/m |
| Pin material | 201(304) |
| Counter flecion | 125.0 mm |
| Running radius | 150.0 mm |
| Characteristic | FDA |
| Temperature | -40~93°C |



Belt Width=70.1 mm

| | | | | | | | | | | |
|--|--|--|--|--|--|--|--|--|--|--|
| | | | | | | | | | | |
| | | | | | | | | | | |
| | | | | | | | | | | |
| | | | | | | | | | | |

Sprocket

| | |
|------------------------|---|
| Tooth Z | - |
| Bore S | - |
| Diameter \varnothing | - |
| Tooth width d | - |
| Sprocket width D | - |
| Material | - |
| Color | - |

Application

Dairy, pharmacy and other industrial that handle small-medium size products

Type: Side flexing table top chain

Code : SF2540TK405

| Specification | |
|---------------------------|-------------|
| Pitch P | 25.4 mm |
| Thickness T | 5.0 mm |
| Pin Dia. D | 6.4 mm |
| Weight | 2.32 kg/m |
| Material | POM |
| Color | White |
| Open area | - |
| Permissible tensile force | 1800 N/m |
| Pin material | 201 (304) |
| Counter flection | 70.0 mm |
| Running radius | 170.0 mm |
| Characteristic | FDA |
| Temperature | -40~93 °C |



Belt Width=102.9 mm * N

| | | | | | | | | | |
|--|--|--|--|--|--|--|--|--|--|
| | | | | | | | | | |
| | | | | | | | | | |
| | | | | | | | | | |
| | | | | | | | | | |

Sprocket

| | |
|------------------|----------|
| Tooth Z | 16 |
| Bore S | 25.0 mm |
| Diameter Ø | 135.0 mm |
| Tooth width d | 7.5 mm |
| Sprocket width D | 45.0 mm |
| Material | PA |
| Color | Black |

Application

Dairy, pharmacy and other industrial that handle small-medium size products

Type: Side flexing table top chain

Code : SF3350TK326

| Specification | |
|---------------------------|-----------|
| Pitch P | 33.5 mm |
| Thickness T | 4.0 mm |
| Pin Dia. D | 6.0 mm |
| Weight | 1.25 kg/m |
| Material | POM |
| Color | Natural |
| Open area | - |
| Permissible tensile force | 1500 N/m |
| Pin material | 201(304) |
| Counter flection | 60.0 mm |
| Running radius | 160.0 mm |
| Characteristic | FDA |
| Temperature | -40~93 °C |



Belt Width=82.8 mm

| | | | | | | | | | |
|--|--|--|--|--|--|--|--|--|--|
| | | | | | | | | | |
| | | | | | | | | | |
| | | | | | | | | | |
| | | | | | | | | | |

Sprocket

| | |
|------------------|------------------------|
| Tooth Z | 12 tooth drive / idler |
| Bore S | 25.0/35.0 mm |
| Diameter Ø | 135.0/125.6 mm |
| Tooth width d | 9.5/- mm |
| Sprocket width D | 51.0 mm |
| Material | PA |
| Color | Black |

Application

Dairy, pharmacy and other industrial that handle small-medium size products

Type: Side flexing table top chain

Code : SG3350TK326

| Specification | |
|---------------------------|-----------|
| Pitch P | 33.5 mm |
| Thickness T | 4.0 mm |
| Pin Dia. D | 6.0 mm |
| Weight | 2.08 kg/m |
| Material | POM |
| Color | Natural |
| Open area | - |
| Permissible tensile force | 1500 N/m |
| Pin material | 201(304) |
| Counter flection | 60.0 mm |
| Running radius | 160.0 mm |
| Characteristic | FDA |
| Temperature | -40~93 °C |



Belt Width=82.8 mm

| | | | | | | | | | |
|--|--|--|--|--|--|--|--|--|--|
| | | | | | | | | | |
| | | | | | | | | | |
| | | | | | | | | | |
| | | | | | | | | | |

Sprocket

| | |
|------------------|------------------------|
| Tooth Z | 12 tooth drive / idler |
| Bore S | 25.0/35.0 mm |
| Diameter Ø | 135/125.6 mm |
| Tooth width d | 9.5/- mm |
| Sprocket width D | 51.0 mm |
| Material | PA |
| Color | Black |

Application

Food, beverages, pharmacy, cosmetics and other industrial that handle small-medium size products

Type: Side flexing table top chain

Code : SF3550TK405

| Specification | |
|---------------------------|-----------|
| Pitch P | 35.5 mm |
| Thickness T | 4.5 mm |
| Pin Dia. D | 6.4 mm |
| Weight | 1.78 kg/m |
| Material | POM |
| Color | Natural |
| Open area | - |
| Permissible tensile force | 1600 N/m |
| Pin material | 201(304) |
| Counter flexion | 70.0 mm |
| Running radius | 170.0 mm |
| Characteristic | FDA |
| Temperature | -40~93 °C |



Belt Width=102.9 mm

| | | | | | | | | | |
|--|--|--|--|--|--|--|--|--|--|
| | | | | | | | | | |
| | | | | | | | | | |
| | | | | | | | | | |
| | | | | | | | | | |

Sprocket

| | |
|------------------|------------------------|
| Tooth Z | 12 tooth drive / idler |
| Bore S | 25.0/35.0 mm |
| Diameter Ø | 146.0/125.0 mm |
| Tooth width d | 8.0/- mm |
| Sprocket width D | 63.0/161.0 mm |
| Material | PA |
| Color | Black |

Application

Dairy, pharmacy and other industrial that handle small-medium size products

Type: Side flexing table top chain

Code : SG3550TK405

| Specification | |
|---------------------------|-------------|
| Pitch P | 35.5 mm |
| Thickness T | 4.0 mm |
| Pin Dia. D | 6.4 mm |
| Weight | 2.06 kg/m |
| Material | POM |
| Color | White |
| Open area | - |
| Permissible tensile force | 1600 N/m |
| Pin material | 201 (304) |
| Counter flection | 70.0 mm |
| Running radius | 170.0 mm |
| Characteristic | FDA |
| Temperature | -40~93 °C |



Belt Width=102.9 mm * N

| | | | | | | | | | |
|--|--|--|--|--|--|--|--|--|--|
| | | | | | | | | | |
| | | | | | | | | | |
| | | | | | | | | | |
| | | | | | | | | | |

Sprocket





| | |
|------------------|------------------------|
| Tooth Z | 12 tooth drive / idler |
| Bore S | 25.0/35.0 mm |
| Diameter Ø | 146.0/125.0 mm |
| Tooth width d | 8.0/- mm |
| Sprocket width D | 63.0/161.0 mm |
| Material | PA |
| Color | Black |

Application

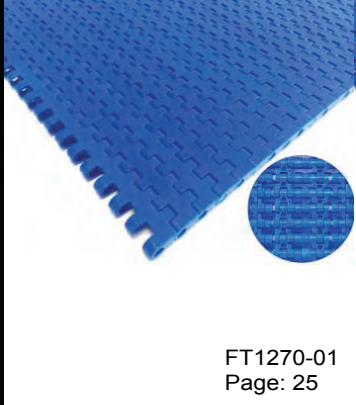

Dairy, pharmacy and other industrial that handle small-medium size products

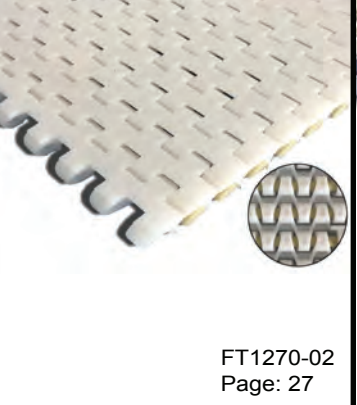
Modular belt

12.70mm Pitch

| | | | |
|---|---|--|---|
|  <p>FT1270-01 Page: 25</p> |  <p>FG1270-01 Page: 26</p> |  <p>FT1270-02 Page: 27</p> |  <p>SG1270-02 Page: 28</p> |
|  <p>FG1270-03 Page: 29</p> | | | |

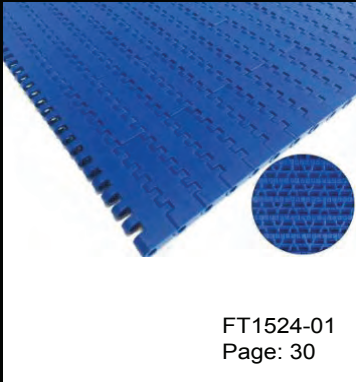
15.24mm Pitch

| | | | |
|--|---|--|--|
|  <p>FT1524-01 Page: 30</p> |  <p>FG1524-01 Page: 31</p> | | |
|--|---|--|--|

19.05mm Pitch

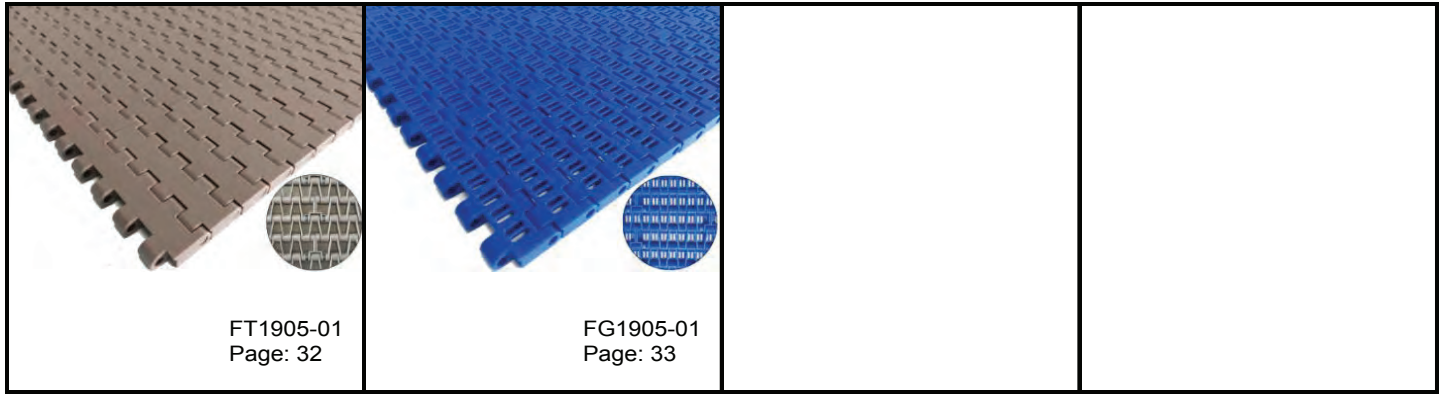

25.00mm Pitch

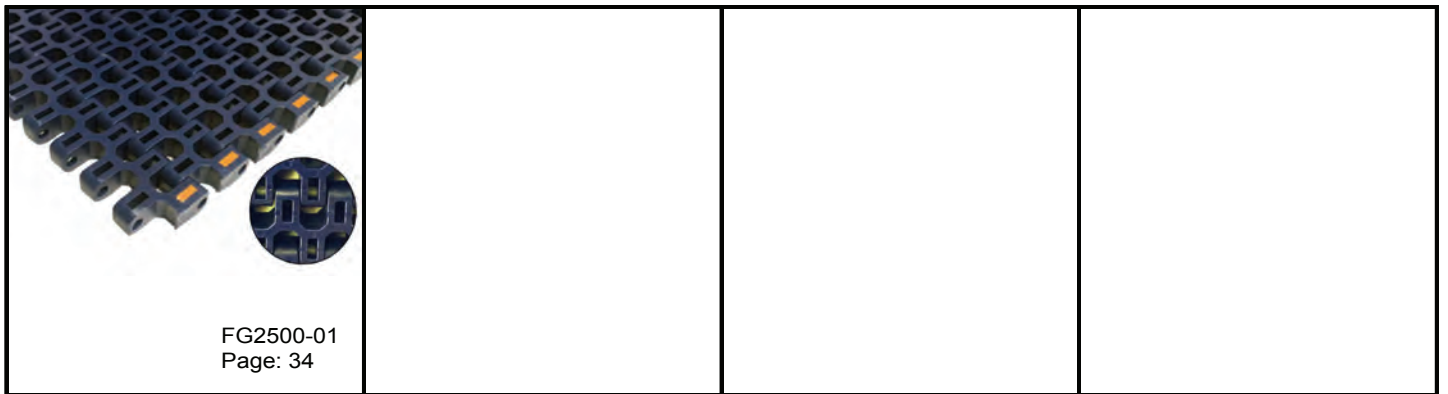

25.40mm Pitch

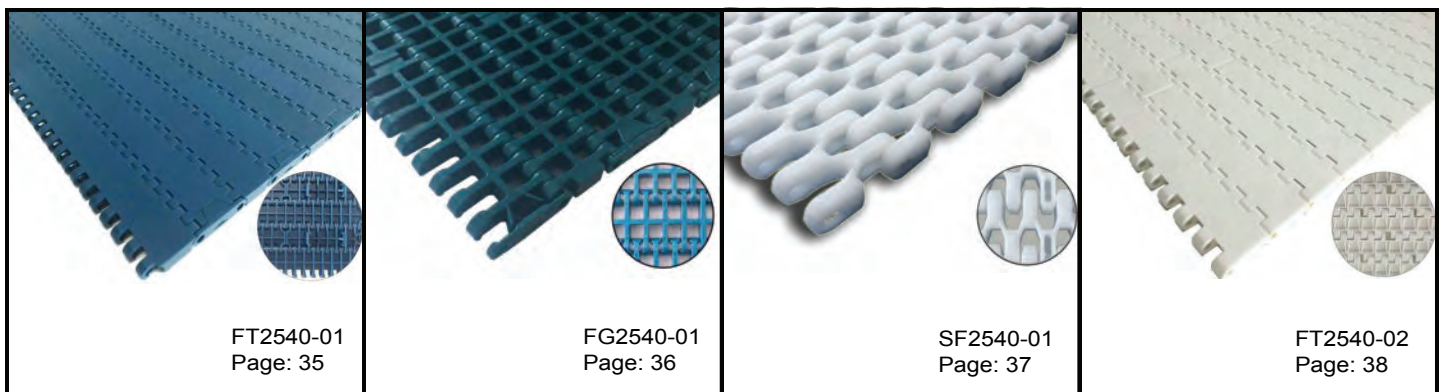

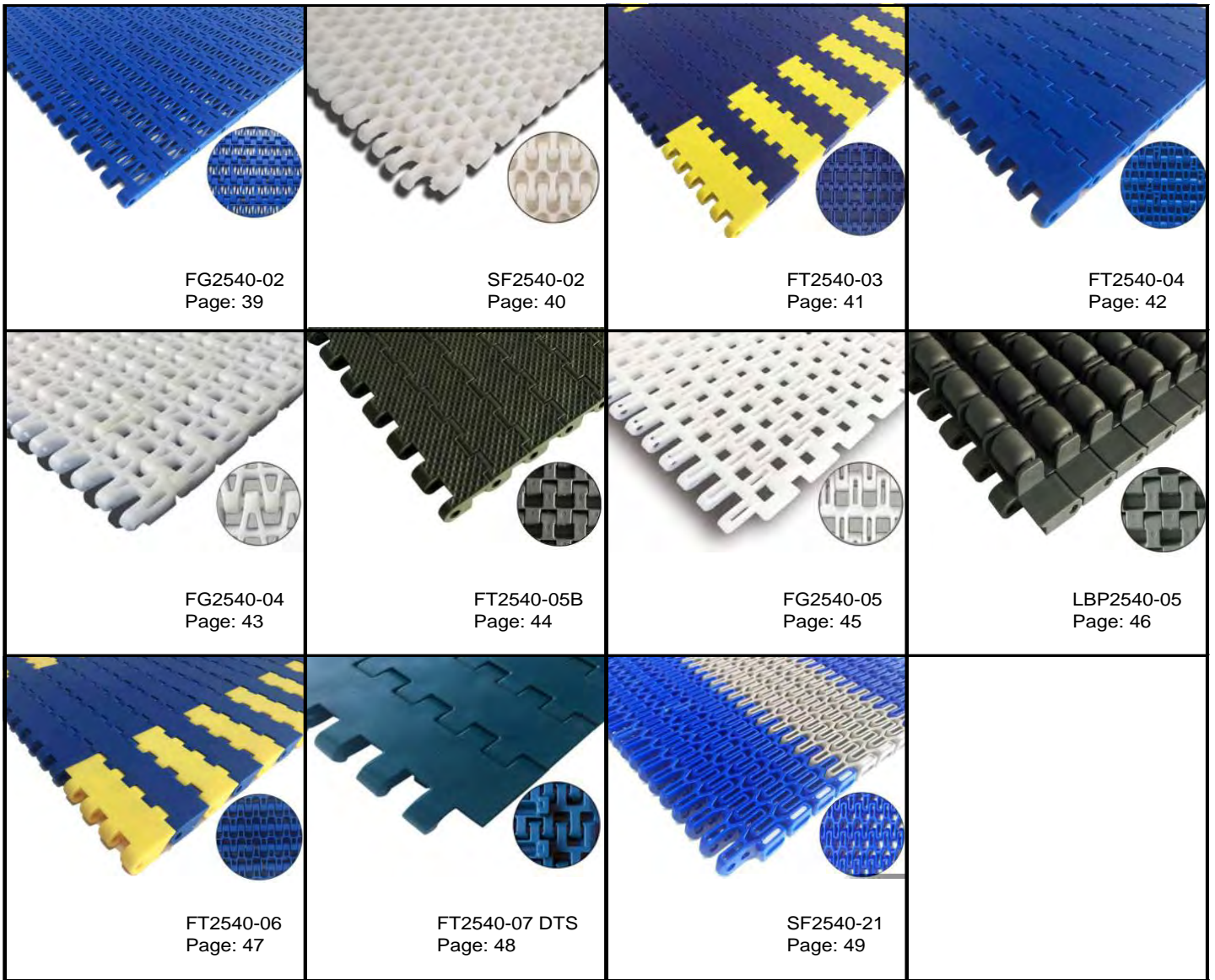

27.20mm Pitch

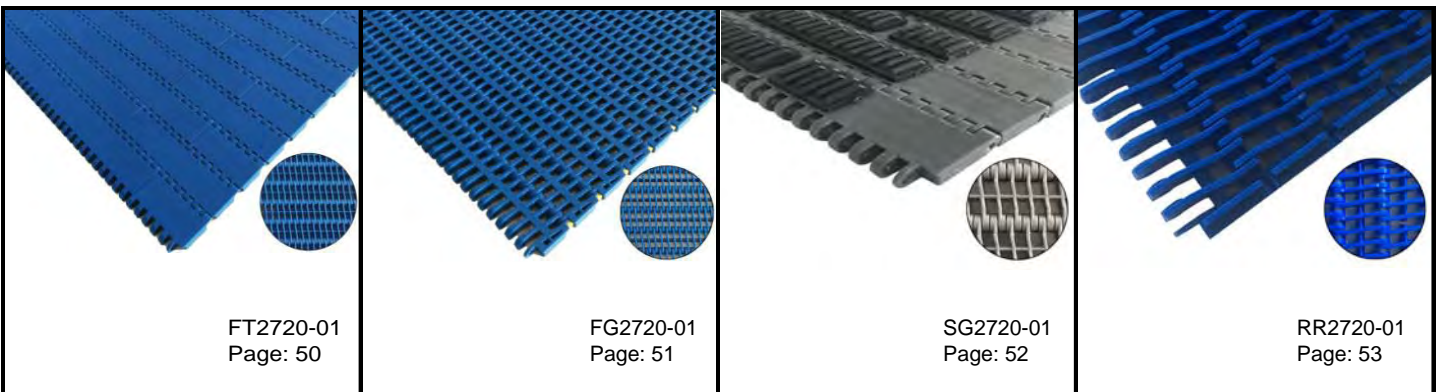



FG2720-02
Page: 54

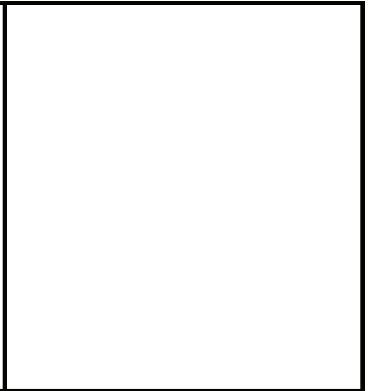
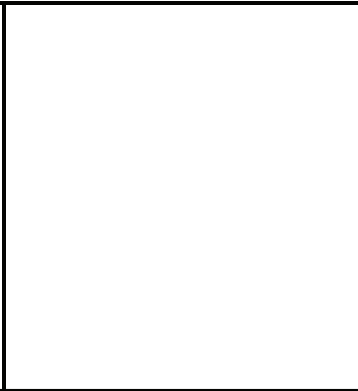

38.10mm Pitch

40.00mm Pitch



FG3810-01
Page: 55

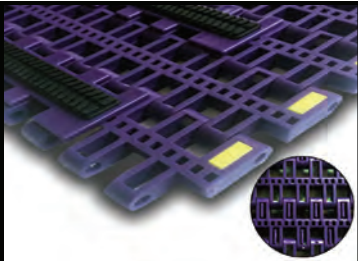
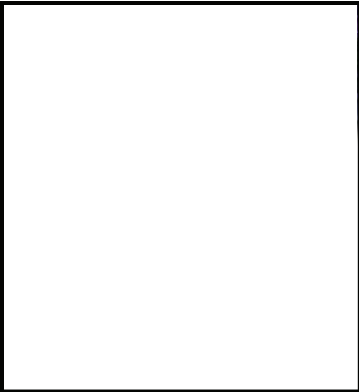

SG4000-01
Page: 56

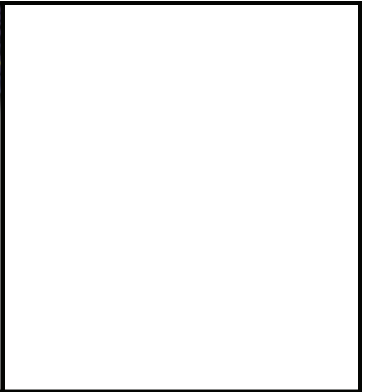

50.80mm Pitch

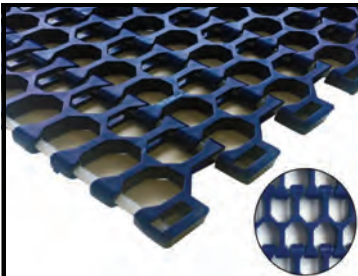

SF5080-01
Page: 57

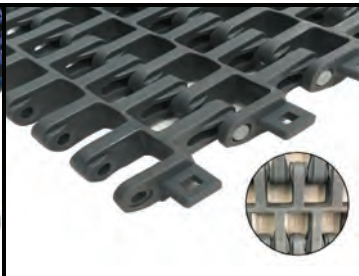

SF5080-02
Page: 58

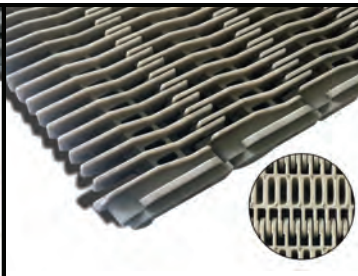

RR5080-02
Page: 59

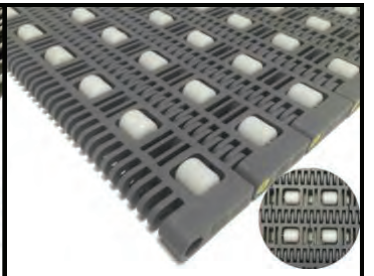

LBP5080-02A
Page: 60

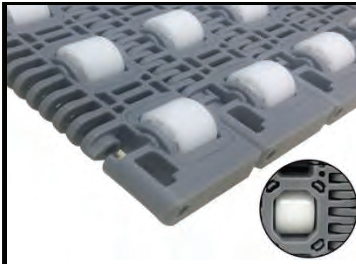

LBP5080-02B
Page: 61



LBP5080-02C
Page: 62



LBP5080-02D
Page: 63

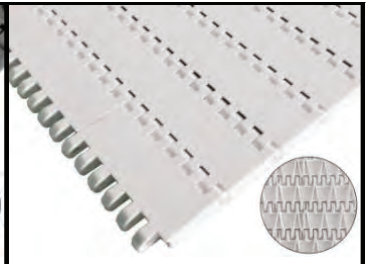

FT5080-03A
Page: 64

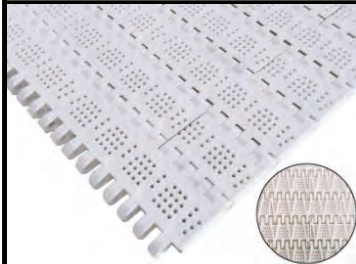

FG5080-03B
Page: 65



FG5080-03C
Page: 66



FG5080-03D
Page: 67

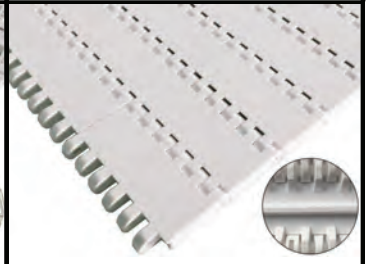

FT5080-04
Page: 68

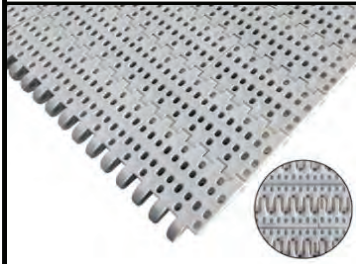

FG5080-04
Page: 69



Type: Flat top plastic modular

Code : FT1270-01

| Specification | |
|---------------------------|-----------------------|
| Pitch P | 12.7 mm |
| Thickness T | 8.7 mm |
| Pin Dia. D | 4.8 mm |
| Weight | 6.1 kg/m ² |
| Material | POM |
| Color | Natural / Blue |
| Open area | - |
| Permissible tensile force | 17000 N/m |
| Pin material | PP(PA) |
| Counter flection | 20.0 mm |
| Running radius | - |
| Characteristic | FDA |
| Temperature | -40~93 °C |

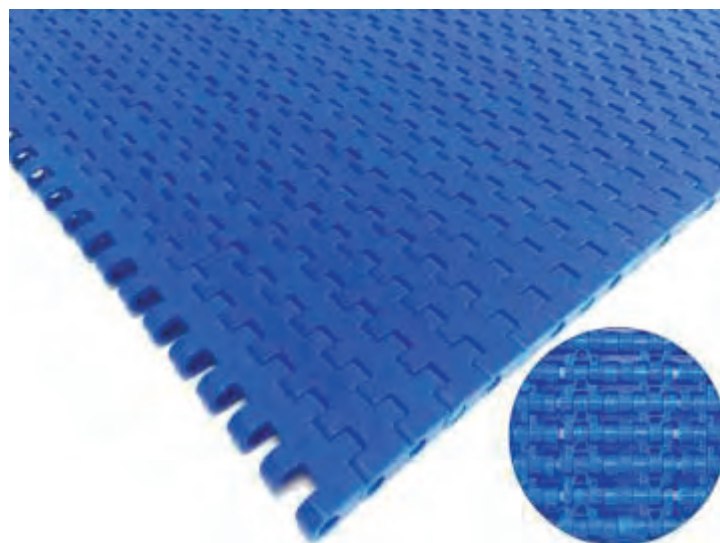

Belt Width=76.2 mm * N

| | | | | | | | | | |
|--------|--------|--------|--------|------|--------|--------|--------|--------|------|
| 76.2 | 152.4 | 228.6 | 304.8 | 381 | 457.2 | 533.4 | 609.6 | 685.8 | 762 |
| 838.2 | 914.4 | 990.6 | 1066.8 | 1143 | 1219.2 | 1295.4 | 1371.6 | 1447.8 | 1524 |
| 1600.2 | 1676.4 | 1752.6 | 1828.8 | 1905 | 1981.2 | 2057.4 | 2133.6 | 2209.8 | 2286 |
| 2362.2 | 2438.4 | 2514.6 | 2590.8 | 2667 | 2743.2 | 2819.4 | 2895.6 | 2971.8 | 3048 |

Sprocket

| | |
|------------------|---------|
| Tooth Z | 24 |
| Bore S | 30.0 mm |
| Diameter Ø | 93.0 mm |
| Tooth width d | 8.0 mm |
| Sprocket width D | 38.0 mm |
| Material | PA |
| Color | Natural |

Application

Food, beverages, dairy, pharmacy, cosmetics and other industrial that handle small-medium size products

Type: Flush grid plastic modular

Code : FG1270-01

| Specification | |
|---------------------------|-----------------------|
| Pitch P | 12.7 mm |
| Thickness T | 8.7 mm |
| Pin Dia. D | 4.8 mm |
| Weight | 5.1 kg/m ² |
| Material | POM |
| Color | Natural / Blue |
| Open area | 14% |
| Permissible tensile force | 17000 N/m |
| Pin material | PP(PA) |
| Counter flection | 20.0 mm |
| Running radius | - |
| Characteristic | FDA |
| Temperature | -40~93 °C |

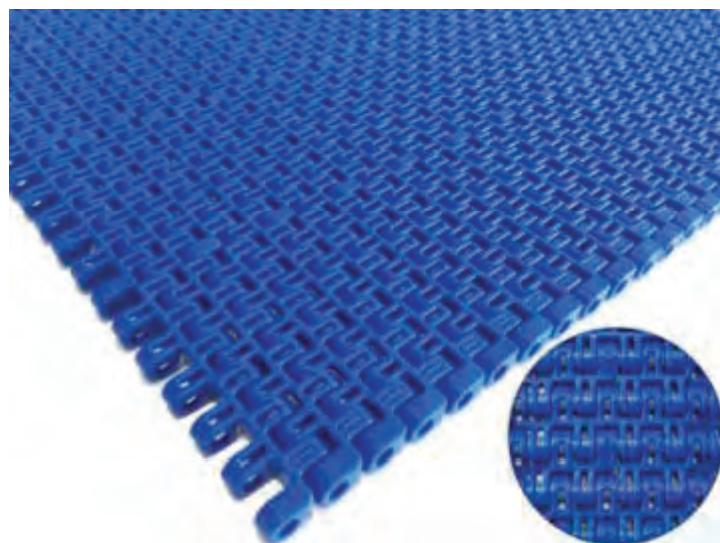

Belt Width=76.2 mm * N

| | | | | | | | | | |
|--------|--------|--------|--------|------|--------|--------|--------|--------|------|
| 76.2 | 152.4 | 228.6 | 304.8 | 381 | 457.2 | 533.4 | 609.6 | 685.8 | 762 |
| 838.2 | 914.4 | 990.6 | 1066.8 | 1143 | 1219.2 | 1295.4 | 1371.6 | 1447.8 | 1524 |
| 1600.2 | 1676.4 | 1752.6 | 1828.8 | 1905 | 1981.2 | 2057.4 | 2133.6 | 2209.8 | 2286 |
| 2362.2 | 2438.4 | 2514.6 | 2590.8 | 2667 | 2743.2 | 2819.4 | 2895.6 | 2971.8 | 3048 |

Sprocket

| | |
|------------------|---------|
| Tooth Z | 24 |
| Bore S | 30.0 mm |
| Diameter Ø | 93.0 mm |
| Tooth width d | 8.0 mm |
| Sprocket width D | 38.0 mm |
| Material | PA |
| Color | Natural |

Application

Food, beverages, dairy, pharmacy, cosmetics and other industrial that handle small-medium size products

Type: Flat top plastic modular

Code : FT1270-02

| Specification | |
|---------------------------|-----------------------|
| Pitch P | 12.7 mm |
| Thickness T | 9.8 mm |
| Pin Dia. D | 5.2 mm |
| Weight | 8.4 kg/m ² |
| Material | POM |
| Color | White |
| Open area | - |
| Permissible tensile force | 22000 N/m |
| Pin material | PP(PA) |
| Counter flection | 20.0 mm |
| Running radius | - |
| Characteristic | FDA |
| Temperature | -40~93 °C |

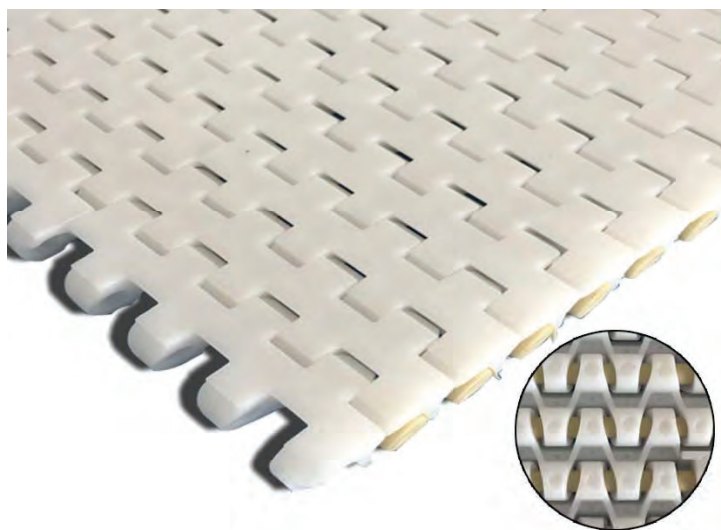

Belt Width=100 mm * N

| | | | | | | | | | |
|------|------|------|------|------|------|------|------|------|------|
| 100 | 200 | 300 | 400 | 500 | 600 | 700 | 800 | 900 | 1000 |
| 1100 | 1200 | 1300 | 1400 | 1500 | 1600 | 1700 | 1800 | 1900 | 2000 |
| 2100 | 2200 | 2300 | 2400 | 2500 | 2600 | 2700 | 2800 | 2900 | 3000 |
| 3100 | 3200 | 3300 | 3400 | 3500 | 3600 | 3700 | 3800 | 3900 | 4000 |

Sprocket

| | |
|------------------|----------|
| Tooth Z | 36 |
| Bore S | 38.0 mm |
| Diameter Ø | 148.0 mm |
| Tooth width d | 12.5 mm |
| Sprocket width D | 30.0 mm |
| Material | POM |
| Color | Natural |

Application

Food, beverages, pharmacy and other industrial that handle small-medium size products

Type: Flat top plastic modular

Code : SG1270-02

| Specification | |
|---------------------------|-----------------------|
| Pitch P | 12.7 mm |
| Thickness T | 13.3 mm |
| Pin Dia. D | 5.2 mm |
| Weight | 4.2 kg/m ² |
| Material | POM |
| Color | White |
| Open area | - |
| Permissible tensile force | 22000 N/m |
| Pin material | PP(PA) |
| Counter flection | 20.0 mm |
| Running radius | - |
| Characteristic | FDA |
| Temperature | -40~93 °C |

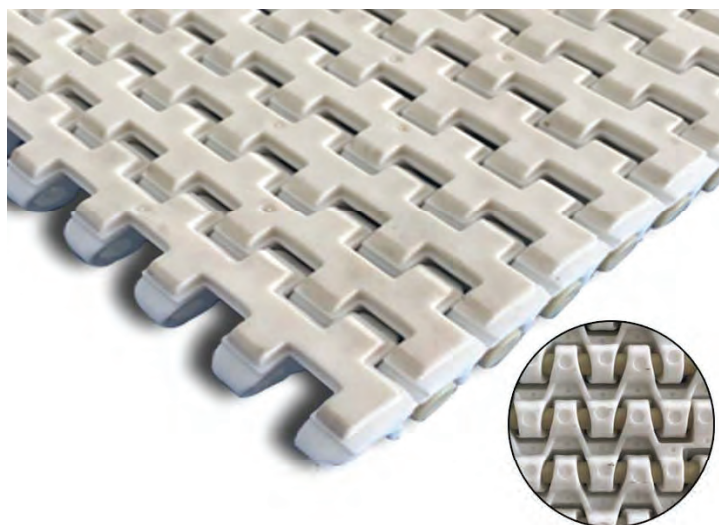

Belt Width=100 mm * N

| | | | | | | | | | |
|------|------|------|------|------|------|------|------|------|------|
| 100 | 200 | 300 | 400 | 500 | 600 | 700 | 800 | 900 | 1000 |
| 1100 | 1200 | 1300 | 1400 | 1500 | 1600 | 1700 | 1800 | 1900 | 2000 |
| 2100 | 2200 | 2300 | 2400 | 2500 | 2600 | 2700 | 2800 | 2900 | 3000 |
| 3100 | 3200 | 3300 | 3400 | 3500 | 3600 | 3700 | 3800 | 3900 | 4000 |

Sprocket

| | |
|------------------|----------|
| Tooth Z | 36 |
| Bore S | 38.0 mm |
| Diameter Ø | 148.0 mm |
| Tooth width d | 12.5 mm |
| Sprocket width D | 30.0 mm |
| Material | POM |
| Color | Natural |

Application

Food, beverages, pharmacy and other industrial that handle small-medium size products

Type: Flush grid plastic modular

Code : FG1270-03

| Specification | |
|---------------------------|-----------------------|
| Pitch P | 12.7 mm |
| Thickness T | 6.35 mm |
| Pin Dia. D | 3.8 mm |
| Weight | 4.5 kg/m ² |
| Material | POM |
| Color | Tan |
| Open area | 40% |
| Permissible tensile force | 2000 N/m |
| Pin material | POM |
| Counter flection | 20.0 mm |
| Running radius | - |
| Characteristic | FDA |
| Temperature | -40~93°C |

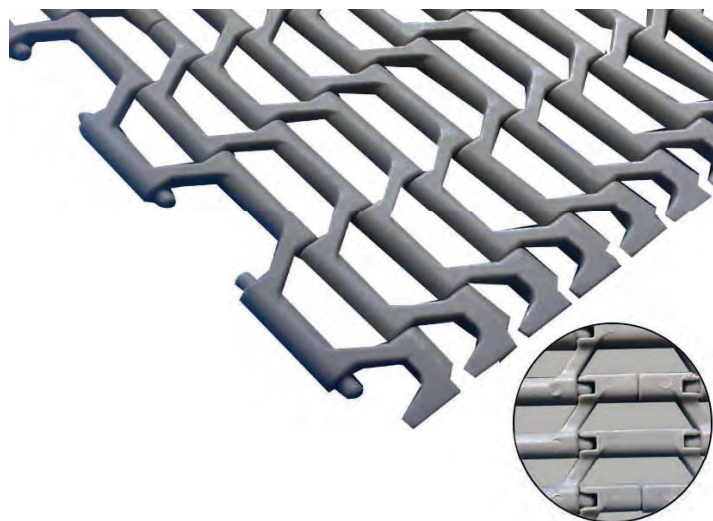

Belt Width=304.8+50.8 mm * N

| | | | | | | | | | |
|--------|--------|--------|--------|------|--------|--------|--------|--------|------|
| 304.8 | 355.6 | 406.4 | 457.2 | 508 | 558.8 | 609.6 | 660.4 | 711.2 | 762 |
| 812.8 | 863.6 | 914.4 | 965.2 | 1016 | 1066.8 | 1117.6 | 1168.4 | 1219.2 | 1270 |
| 1320.8 | 1371.6 | 1422.4 | 1473.2 | 1524 | 1574.8 | 1625.6 | 1676.4 | 1727.2 | 1778 |
| 1828.8 | 1879.6 | 1930.4 | 1981.2 | 2032 | 2082.8 | 2133.6 | 2184.4 | 2235.2 | 2286 |

Sprocket

| | |
|------------------|---------|
| Tooth Z | 16 |
| Bore R | 30.0 mm |
| Diameter Ø | 78 mm |
| Tooth width d | 30.0 mm |
| Sprocket width D | 30.0 mm |
| Material | PA |
| Color | Natural |

Application

Food and other industrial that handle small-medium size products

Type: Flat top plastic modular

Code : FT1524-01

| Specification | |
|---------------------------|-----------------------|
| Pitch P | 15.24 mm |
| Thickness T | 8.7 mm |
| Pin Dia. D | 4.8 mm |
| Weight | 6.5 kg/m ² |
| Material | POM |
| Color | Blue |
| Open area | - |
| Permissible tensile force | 17000 N/m |
| Pin material | PP(PA) |
| Counter flection | 25.0 mm |
| Running radius | - |
| Characteristic | FDA |
| Temperature | -40~93 °C |

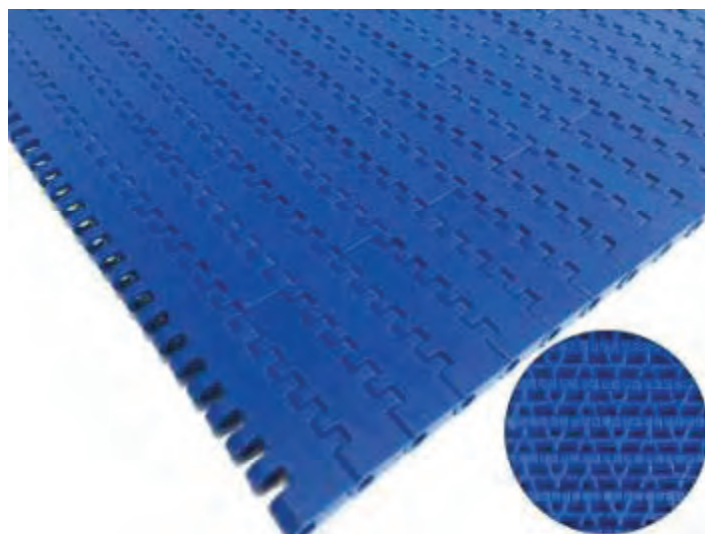

Belt Width=152.4+50.8 mm * N

| | | | | | | | | | |
|--------|--------|------|--------|--------|--------|--------|------|--------|--------|
| 152.4 | 203.2 | 254 | 304.8 | 355.6 | 406.4 | 457.2 | 508 | 558.8 | 609.6 |
| 660.4 | 711.2 | 762 | 812.8 | 863.6 | 914.4 | 965.2 | 1016 | 1066.8 | 1117.6 |
| 1168.4 | 1219.2 | 1270 | 1320.8 | 1371.6 | 1422.4 | 1473.2 | 1524 | 1574.8 | 1625.6 |
| 1676.4 | 1727.2 | 1778 | 1828.8 | 1879.6 | 1930.4 | 1981.2 | 2032 | 2082.8 | 2133.6 |

Sprocket

| | |
|------------------|----------|
| Tooth Z | 24 |
| Bore S | 40.0 mm |
| Diameter Ø | 116.3 mm |
| Tooth width d | 5.8 mm |
| Sprocket width D | 25.0 mm |
| Material | POM |
| Color | Natural |

Application

Food, beverages, pharmacy, cosmetics and other industrial that handle small-medium size products

Type: Flush grid plastic modular

Code : FG1524-01

| Specification | |
|---------------------------|-----------------------|
| Pitch P | 15.24 mm |
| Thickness T | 8.7 mm |
| Pin Dia. D | 4.8 mm |
| Weight | 5.6 kg/m ² |
| Material | POM |
| Color | Blue |
| Open area | 39% |
| Permissible tensile force | 17000 N/m |
| Pin material | PP(PA) |
| Counter flection | 25.0 mm |
| Running radius | - |
| Characteristic | FDA |
| Temperature | -40~93 °C |

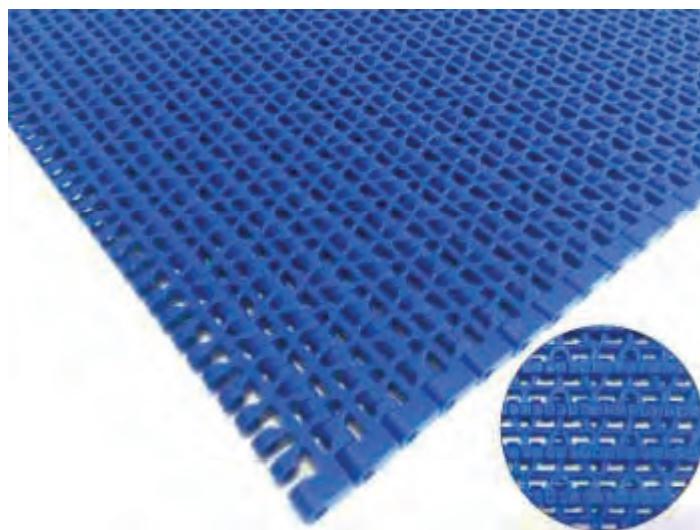

Belt Width=152.4+50.8 mm * N

| | | | | | | | | | |
|--------|--------|------|--------|--------|--------|--------|------|--------|--------|
| 152.4 | 203.2 | 254 | 304.8 | 355.6 | 406.4 | 457.2 | 508 | 558.8 | 609.6 |
| 660.4 | 711.2 | 762 | 812.8 | 863.6 | 914.4 | 965.2 | 1016 | 1066.8 | 1117.6 |
| 1168.4 | 1219.2 | 1270 | 1320.8 | 1371.6 | 1422.4 | 1473.2 | 1524 | 1574.8 | 1625.6 |
| 1676.4 | 1727.2 | 1778 | 1828.8 | 1879.6 | 1930.4 | 1981.2 | 2032 | 2082.8 | 2133.6 |

Sprocket

| | |
|------------------|----------|
| Tooth Z | 24 |
| Bore S | 40.0 mm |
| Diameter Ø | 116.3 mm |
| Tooth width d | 5.8 mm |
| Sprocket width D | 25.0 mm |
| Material | POM |
| Color | Natural |

Application

Food, beverages, pharmacy, cosmetics and other industrial that handle small-medium size products

Type: Flat top plastic modular

Code : FT1905-01

| Specification | |
|---------------------------|-----------------------|
| Pitch P | 19.05 mm |
| Thickness T | 8.7 mm |
| Pin Dia. D | 4.8 mm |
| Weight | 6.7 kg/m ² |
| Material | POM |
| Color | Natural / Tan |
| Open area | - |
| Permissible tensile force | 17000 N/m |
| Pin material | PP(PA) |
| Counter flection | 30.0 mm |
| Running radius | - |
| Characteristic | FDA |
| Temperature | -40~93 °C |

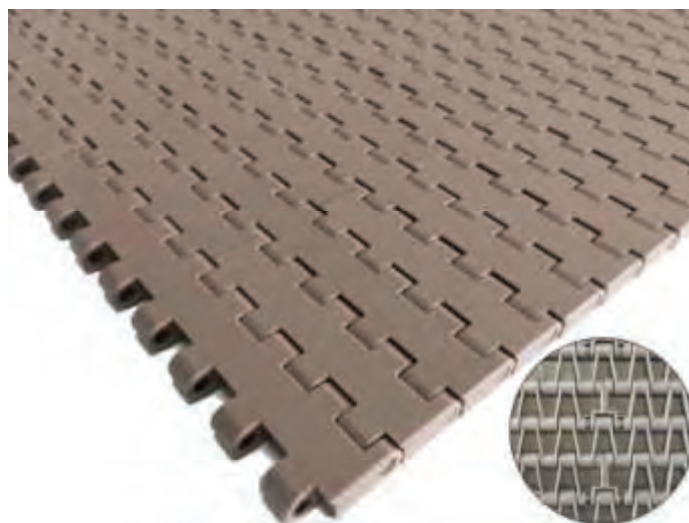

Belt Width=76.2 mm * N

| | | | | | | | | | |
|--------|--------|--------|--------|------|--------|--------|--------|--------|------|
| 76.2 | 152.4 | 228.6 | 304.8 | 381 | 457.2 | 533.4 | 609.6 | 685.8 | 762 |
| 838.2 | 914.4 | 990.6 | 1066.8 | 1143 | 1219.2 | 1295.4 | 1371.6 | 1447.8 | 1524 |
| 1600.2 | 1676.4 | 1752.6 | 1828.8 | 1905 | 1981.2 | 2057.4 | 2133.6 | 2209.8 | 2286 |
| 2362.2 | 2438.4 | 2514.6 | 2590.8 | 2667 | 2743.2 | 2819.4 | 2895.6 | 2971.8 | 3048 |

Sprocket

| | |
|------------------|----------|
| Tooth Z | 17 |
| Bore S | 25.0 mm |
| Diameter Ø | 106.4 mm |
| Tooth width d | 4.8 mm |
| Sprocket width D | 25.0 mm |
| Material | POM |
| Color | Natural |

Application

Food, beverages, Dairy, pharmacy, cosmetics and other industrial that handle small-medium size products

Type: Flush grid plastic modular

Code : FG1905-01

| Specification | |
|---------------------------|-----------------------|
| Pitch P | 19.05 mm |
| Thickness T | 8.7 mm |
| Pin Dia. D | 4.8 mm |
| Weight | 6.1 kg/m ² |
| Material | POM |
| Color | Natural / Tan / Blue |
| Open area | 16% |
| Permissible tensile force | 17000 N/m |
| Pin material | PP(PA) |
| Counter flection | 30.0 mm |
| Running radius | - |
| Characteristic | FDA |
| Temperature | -40~93 °C |

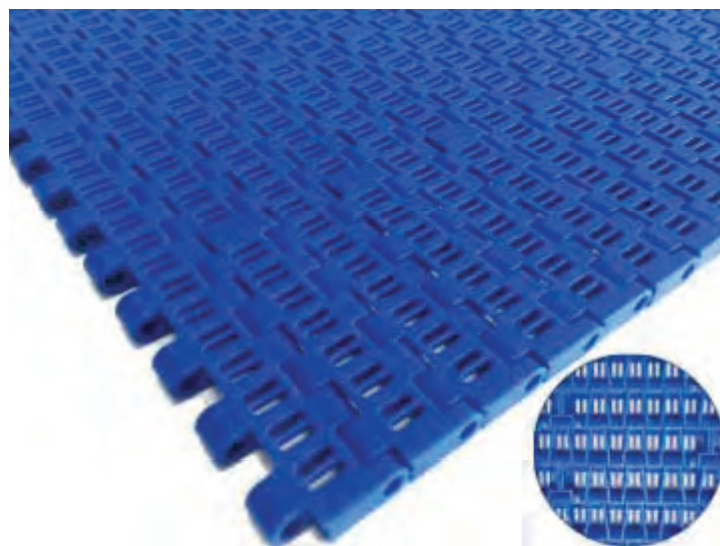

Belt Width=76.2 mm * N

| | | | | | | | | | |
|--------|--------|--------|--------|------|--------|--------|--------|--------|------|
| 76.2 | 152.4 | 228.6 | 304.8 | 381 | 457.2 | 533.4 | 609.6 | 685.8 | 762 |
| 838.2 | 914.4 | 990.6 | 1066.8 | 1143 | 1219.2 | 1295.4 | 1371.6 | 1447.8 | 1524 |
| 1600.2 | 1676.4 | 1752.6 | 1828.8 | 1905 | 1981.2 | 2057.4 | 2133.6 | 2209.8 | 2286 |
| 2362.2 | 2438.4 | 2514.6 | 2590.8 | 2667 | 2743.2 | 2819.4 | 2895.6 | 2971.8 | 3048 |

Sprocket

| | |
|------------------|----------|
| Tooth Z | 17 |
| Bore S | 25.0 mm |
| Diameter Ø | 106.4 mm |
| Tooth width d | 4.8 mm |
| Sprocket width D | 25.0 mm |
| Material | POM |
| Color | Natural |

Application

Food, beverages, Dairy, pharmacy, cosmetics and other industrial that handle small-medium size products

Type: Flush grid plastic modular

Code : FG2500-01

| Specification | |
|---------------------------|-----------------------|
| Pitch P | 25.0 mm |
| Thickness T | 12.7 mm |
| Pin Dia. D | 5.2 mm |
| Weight | 7.2 kg/m ² |
| Material | POM |
| Color | Blue / White |
| Open area | - |
| Permissible tensile force | 2000 N/m |
| Pin material | PP(PA) |
| Counter flection | 35.0 mm |
| Running radius | - |
| Characteristic | FDA |
| Temperature | -40~93 °C |

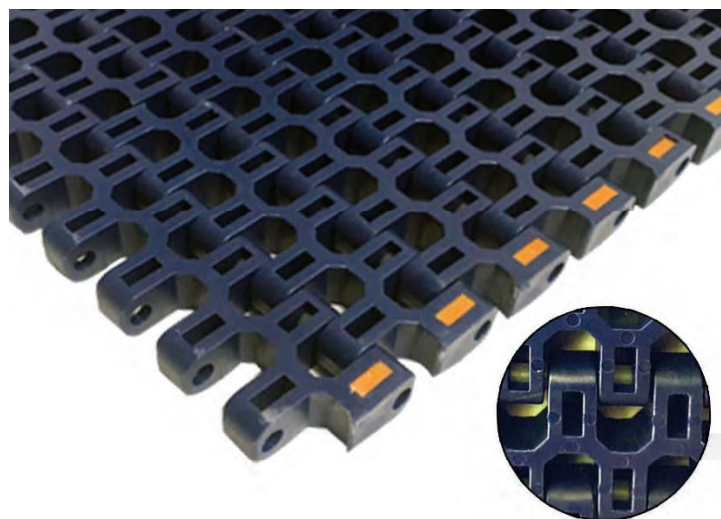

Belt Width=100 mm * N

| | | | | | | | | | |
|------|------|------|------|------|------|------|------|------|------|
| 100 | 200 | 300 | 400 | 500 | 600 | 700 | 800 | 900 | 1000 |
| 1100 | 1200 | 1300 | 1400 | 1500 | 1600 | 1700 | 1800 | 1900 | 2000 |
| 2100 | 2200 | 2300 | 2400 | 2500 | 2600 | 2700 | 2800 | 2900 | 3000 |
| 3100 | 3200 | 3300 | 3400 | 3500 | 3600 | 3700 | 3800 | 3900 | 4000 |

Sprocket

| | |
|------------------|----------|
| Tooth Z | 24 |
| Bore S | 60.0 mm |
| Diameter Ø | 195.0 mm |
| Tooth width d | 5.8 mm |
| Sprocket width D | 30.0 mm |
| Material | POM |
| Color | Natural |

Application

Food and other industrial that handle small-medium size products

Type: Flat top plastic modular

Code : FT2540-01

| Specification | |
|---------------------------|-----------------------|
| Pitch P | 25.4 mm |
| Thickness T | 8.7 mm |
| Pin Dia. D | 4.8 mm |
| Weight | 6.1 kg/m ² |
| Material | POM |
| Color | Dark green |
| Open area | - |
| Permissible tensile force | 22000 N/m |
| Pin material | PP(PA) |
| Counter flection | 35.0 mm |
| Running radius | - |
| Characteristic | FDA |
| Temperature | -40~93 °C |

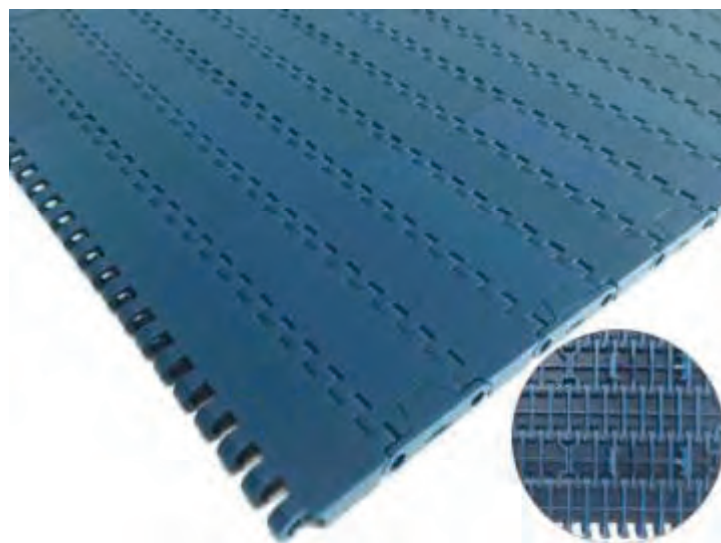

Belt Width=85 mm * N

| | | | | | | | | | |
|------|------|------|------|------|------|------|------|------|------|
| 85 | 170 | 255 | 340 | 425 | 510 | 595 | 680 | 765 | 850 |
| 935 | 1020 | 1105 | 1190 | 1275 | 1360 | 1445 | 1530 | 1615 | 1700 |
| 1785 | 1870 | 1955 | 2040 | 2125 | 2210 | 2295 | 2380 | 2465 | 2550 |
| 2635 | 2720 | 2805 | 2890 | 2975 | 3060 | 3145 | 3230 | 3315 | 3400 |

Sprocket

| | |
|------------------|---------------|
| Tooth Z | 12/18 |
| Bore S | 30.0/40.0 mm |
| Diameter Ø | 99.4/147.5 mm |
| Tooth width d | 6.0 mm |
| Sprocket width D | 39.0 mm |
| Material | PA |
| Color | Black |

Application

Food, beverages and other industrial that handle small-medium size products

Type: Flush grid plastic modular

Code : FG2540-01

| Specification | |
|---------------------------|-----------------------|
| Pitch P | 25.4 mm |
| Thickness T | 8.7 mm |
| Pin Dia. D | 4.8 mm |
| Weight | 4.2 kg/m ² |
| Material | POM |
| Color | Dark green |
| Open area | 40% |
| Permissible tensile force | 22000 N/m |
| Pin material | PP(PA) |
| Counter flection | 35.0 mm |
| Running radius | - |
| Characteristic | FDA |
| Temperature | -40~93 °C |

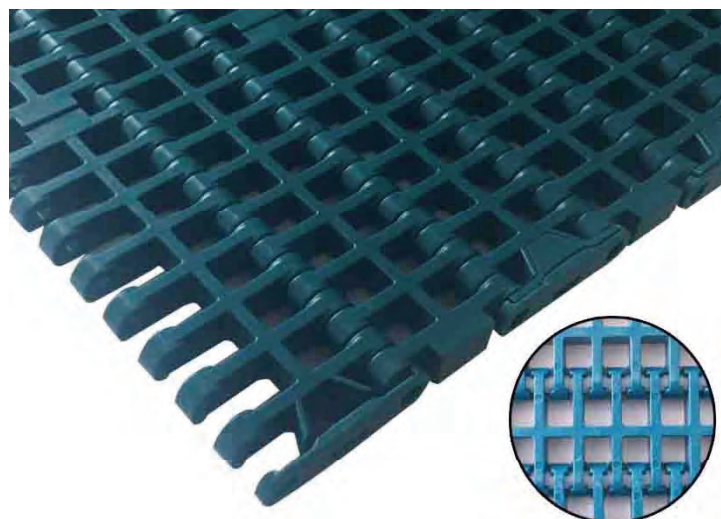

Belt Width=85 mm * N

| | | | | | | | | | |
|------|------|------|------|------|------|------|------|------|------|
| 85 | 170 | 255 | 340 | 425 | 510 | 595 | 680 | 765 | 850 |
| 935 | 1020 | 1105 | 1190 | 1275 | 1360 | 1445 | 1530 | 1615 | 1700 |
| 1785 | 1870 | 1955 | 2040 | 2125 | 2210 | 2295 | 2380 | 2465 | 2550 |
| 2635 | 2720 | 2805 | 2890 | 2975 | 3060 | 3145 | 3230 | 3315 | 3400 |

Sprocket

| | |
|------------------|---------------|
| Tooth Z | 12/18 |
| Bore S | 30.0/40.0 mm |
| Diameter Ø | 99.4/147.5 mm |
| Tooth width d | 6.0 mm |
| Sprocket width D | 39.0 mm |
| Material | PA |
| Color | Black |

Application

Food, beverages and other industrial that handle small-medium size products

Type: Side flexing plastic modular

Code : SF2540-01

| Specification | |
|---------------------------|-----------------------|
| Pitch P | 25.4 mm |
| Thickness T | 12.7 mm |
| Pin Dia. D | 4.8 mm |
| Weight | 7.6 kg/m ² |
| Material | POM |
| Color | Blue / White |
| Open area | - |
| Permissible tensile force | 22000 N/m |
| Pin material | PP(PA) |
| Counter flection | 35.0 mm |
| Running radius | Belt width *2.5 |
| Characteristic | FDA |
| Temperature | -40~93 °C |

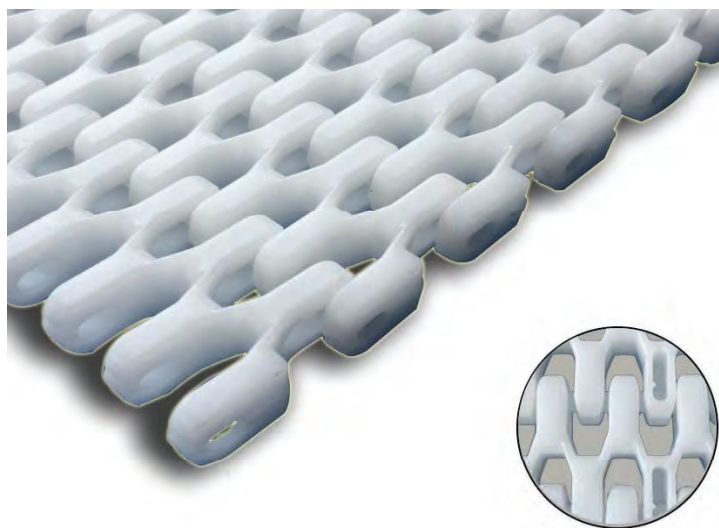

Belt Width=304.8+50.8 mm * N

| | | | | | | | | | |
|--------|--------|--------|--------|------|--------|--------|--------|--------|------|
| 304.8 | 355.6 | 406.4 | 457.2 | 508 | 558.8 | 609.6 | 660.4 | 711.2 | 762 |
| 812.8 | 863.6 | 914.4 | 965.2 | 1016 | 1066.8 | 1117.6 | 1168.4 | 1219.2 | 1270 |
| 1320.8 | 1371.6 | 1422.4 | 1473.2 | 1524 | 1574.8 | 1625.6 | 1676.4 | 1727.2 | 1778 |
| 1828.8 | 1879.6 | 1930.4 | 1981.2 | 2032 | 2082.8 | 2133.6 | 2184.4 | 2235.2 | 2286 |

Sprocket

| | |
|------------------|----------|
| Tooth Z | 15 |
| Bore R | 30.0 mm |
| Diameter Ø | 120.5 mm |
| Tooth width d | 5.0 mm |
| Sprocket width D | 37.0 mm |
| Material | PA |
| Color | Natural |

Application

Food, dairy, pharmacy and other industrial that handle small-medium size products

Type: Flat top plastic modular

Code : FT2540-02

| Specification | |
|---------------------------|-----------------------|
| Pitch P | 25.4 mm |
| Thickness T | 8.7 mm |
| Pin Dia. D | 4.8 mm |
| Weight | 4.7 kg/m ² |
| Material | PP(PA) |
| Color | White |
| Open area | - |
| Permissible tensile force | 20000 N/m |
| Pin material | PP(PA) |
| Counter flection | 35.0 mm |
| Running radius | - |
| Characteristic | FDA |
| Temperature | 0~104 °C |

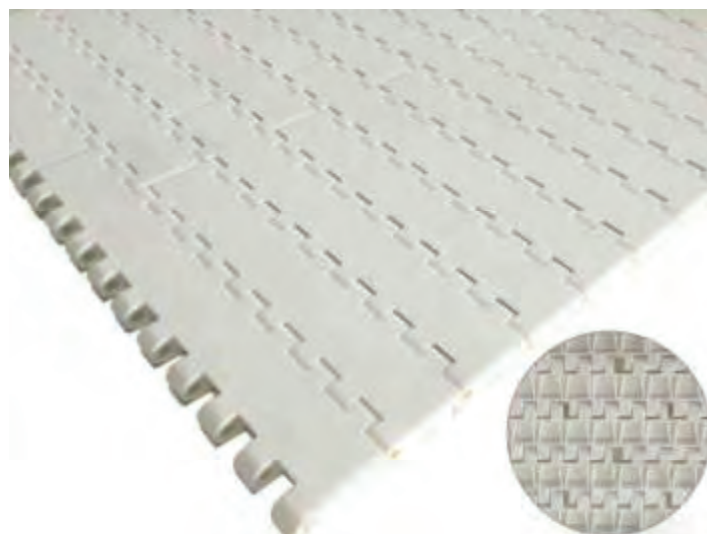

Belt Width=121.9+(30.5+121.9) mm * N

| | | | | | | | | | |
|--------|--------|--------|--------|--------|--------|--------|--------|-------|--------|
| 121.9 | 152.4 | 274.3 | 396.2 | 426.7 | 548.6 | 579.1 | 701 | 731.5 | 853.4 |
| 883.9 | 1005.8 | 1035.8 | 1157.7 | 1188.2 | 1310.1 | 1340.6 | 1462.5 | 1493 | 1614.9 |
| 1645.4 | 1767.3 | 1797.8 | 1919.7 | 1950.2 | 2072.1 | 2102.6 | 2224.5 | 2255 | 2376.9 |
| 2407.4 | 2529.3 | 2559.8 | 2681.7 | 2712.2 | 2834.1 | 2864.6 | 2986.5 | 3017 | 3138.9 |

Sprocket

| | |
|------------------|---------|
| Tooth Z | 12 |
| Bore S | 40.0 mm |
| Diameter Ø | 99.0 mm |
| Tooth width d | 8.5 mm |
| Sprocket width D | 25.0 mm |
| Material | PA |
| Color | Natural |

Application

Food, beverages, pharmacy, clothing and other industrial that handle small-medium size products

Type: Flush grid plastic modular

Code : **FG2540-02**

| Specification | |
|---------------------------|--------------------------|
| Pitch P | 25.4 mm |
| Thickness T | 8.7 mm |
| Pin Dia. D | 4.8 mm |
| Weight | 4.3/6.7kg/m ² |
| Material | PP/POM |
| Color | Grey / Blue |
| Open area | 23% |
| Permissible tensile force | 19000/22000 N/m |
| Pin material | PP(PA) |
| Counter flection | 35.0 mm |
| Running radius | - |
| Characteristic | FDA/- |
| Temperature | 0~104 °C/-40~93°C |

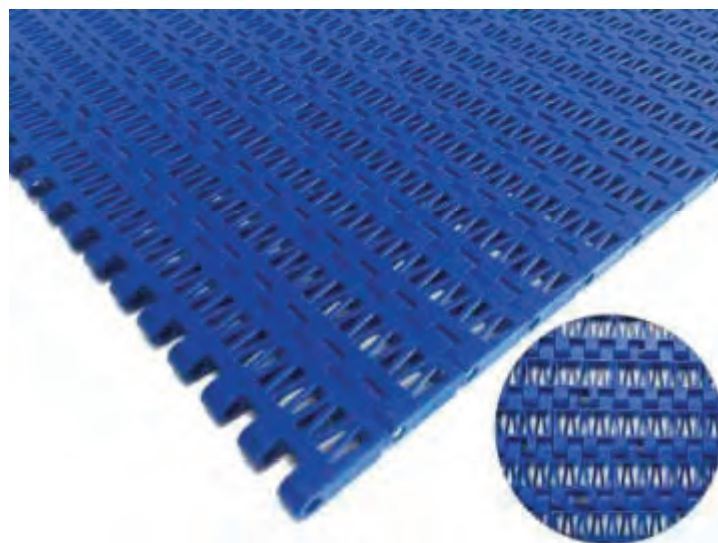

Belt Width=121.9+(30.5+121.9) mm * N

| | | | | | | | | | |
|--------|--------|--------|--------|--------|--------|--------|--------|-------|--------|
| 121.9 | 152.4 | 274.3 | 396.2 | 426.7 | 548.6 | 579.1 | 701 | 731.5 | 853.4 |
| 883.9 | 1005.8 | 1035.8 | 1157.7 | 1188.2 | 1310.1 | 1340.6 | 1462.5 | 1493 | 1614.9 |
| 1645.4 | 1767.3 | 1797.8 | 1919.7 | 1950.2 | 2072.1 | 2102.6 | 2224.5 | 2255 | 2376.9 |
| 2407.4 | 2529.3 | 2559.8 | 2681.7 | 2712.2 | 2834.1 | 2864.6 | 2986.5 | 3017 | 3138.9 |

Sprocket

| | |
|------------------|---------|
| Tooth Z | 12 |
| Bore S | 40.0 mm |
| Diameter Ø | 99.0 mm |
| Tooth width d | 8.5 mm |
| Sprocket width D | 25.0 mm |
| Material | PA |
| Color | Natural |

Application

Food, beverages, pharmacy, cosmetics, clothing and other industrial that handle small-medium size products

Type: Side flexing plastic modular

Code : SF2540-02

| Specification | |
|---------------------------|-----------------------|
| Pitch P | 25.4 mm |
| Thickness T | 12.7 mm |
| Pin Dia. D | 4.8 mm |
| Weight | 7.4 kg/m ² |
| Material | POM |
| Color | White |
| Open area | 36% |
| Permissible tensile force | 22000 N/m |
| Pin material | PP(PA) |
| Counter flection | 35.0 mm |
| Running radius | Belt width *2.3 |
| Characteristic | FDA |
| Temperature | -40~93 °C |

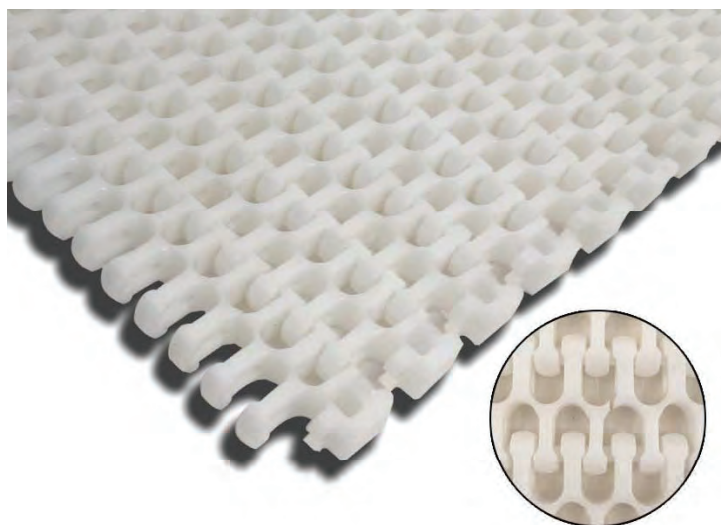

Belt Width=304.8+50.8 mm * N

| | | | | | | | | | |
|--------|--------|--------|--------|------|--------|--------|--------|--------|------|
| 304.8 | 355.6 | 406.4 | 457.2 | 508 | 558.8 | 609.6 | 660.4 | 711.2 | 762 |
| 812.8 | 863.6 | 914.4 | 965.2 | 1016 | 1066.8 | 1117.6 | 1168.4 | 1219.2 | 1270 |
| 1320.8 | 1371.6 | 1422.4 | 1473.2 | 1524 | 1574.8 | 1625.6 | 1676.4 | 1727.2 | 1778 |
| 1828.8 | 1879.6 | 1930.4 | 1981.2 | 2032 | 2082.8 | 2133.6 | 2184.4 | 2235.2 | 2286 |

Sprocket

| | |
|------------------|----------|
| Tooth Z | 16 |
| Bore S | 50.0mm |
| Diameter Ø | 130.0 mm |
| Tooth width d | 6.8 mm |
| Sprocket width D | 35.0 mm |
| Material | POM |
| Color | Natural |

Application

Dairy, pharmacy and other industrial that handle small-medium size products

Type: Flat top plastic modular

Code : FT2540-03

| Specification | |
|---------------------------|-----------------------|
| Pitch P | 25.4 mm |
| Thickness T | 8.7 mm |
| Pin Dia. D | 5.2 mm |
| Weight | 7.3 kg/m ² |
| Material | POM |
| Color | Yellow / Dark blue |
| Open area | - |
| Permissible tensile force | 25000 N/m |
| Pin material | PP(PA) |
| Counter flection | 35.0 mm |
| Running radius | - |
| Characteristic | FDA |
| Temperature | -40~93 °C |

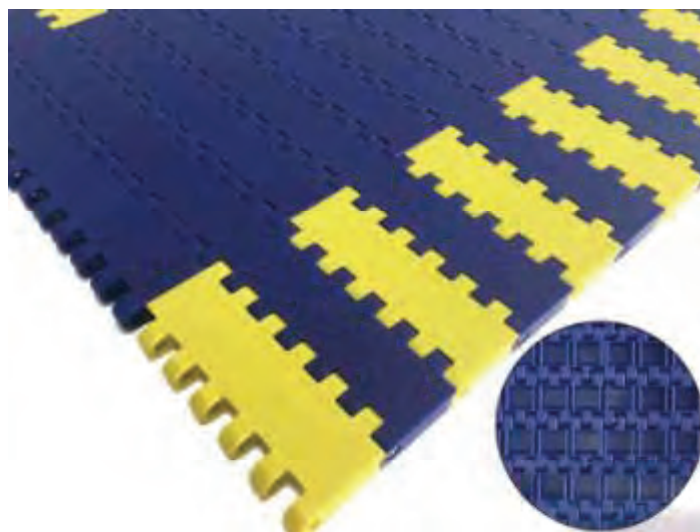

Belt Width=76.2 mm * N

| | | | | | | | | | |
|--------|--------|--------|--------|------|--------|--------|--------|--------|------|
| 76.2 | 152.4 | 228.6 | 304.8 | 381 | 457.2 | 533.4 | 609.6 | 685.8 | 762 |
| 838.2 | 914.4 | 990.6 | 1066.8 | 1143 | 1219.2 | 1295.4 | 1371.6 | 1447.8 | 1524 |
| 1600.2 | 1676.4 | 1752.6 | 1828.8 | 1905 | 1981.2 | 2057.4 | 2133.6 | 2209.8 | 2286 |
| 2362.2 | 2438.4 | 2514.6 | 2590.8 | 2667 | 2743.2 | 2819.4 | 2895.6 | 2971.8 | 3048 |

Sprocket

| | |
|------------------|----------|
| Tooth Z | 15 |
| Bore S | 38.0 mm |
| Diameter Ø | 121.6 mm |
| Tooth width d | 10.0mm |
| Sprocket width D | 30.0 mm |
| Material | POM |
| Color | Natural |

Application

Corrugated paper, logistic and other industrial that handle small-medium size products

Type: Flat top plastic modular

Code : FT2540-04

| Specification | |
|---------------------------|-----------------------|
| Pitch P | 25.4 mm |
| Thickness T | 9.8 mm |
| Pin Dia. D | 5.2 mm |
| Weight | 6.7 kg/m ² |
| Material | PP |
| Color | Yellow / Blue |
| Open area | - |
| Permissible tensile force | 22000 N/m |
| Pin material | PP(PA) |
| Counter flection | 35.0 mm |
| Running radius | - |
| Characteristic | FDA |
| Temperature | 0~104 °C |

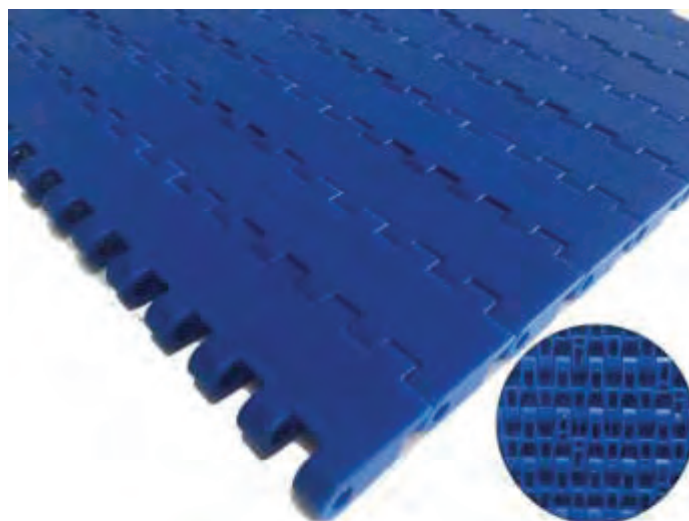

Belt Width=50 mm * N

| | | | | | | | | | |
|------|------|------|------|------|------|------|------|------|------|
| 50 | 100 | 150 | 200 | 250 | 300 | 350 | 400 | 450 | 500 |
| 550 | 600 | 650 | 700 | 750 | 800 | 850 | 900 | 950 | 1000 |
| 1050 | 1100 | 1150 | 1200 | 1250 | 1300 | 1350 | 1400 | 1450 | 1500 |
| 1550 | 1600 | 1650 | 1700 | 1750 | 1800 | 1850 | 1900 | 1950 | 2000 |

Sprocket

| | |
|------------------|----------------|
| Tooth Z | 12/20 |
| Bore S | 40.0 mm |
| Diameter Ø | 100.0/165.0 mm |
| Tooth width d | 6.0 mm |
| Sprocket width D | 30.0 mm |
| Material | PA |
| Color | Natural |

Application

Corrugated paper, logistic and other industrial that handle small-medium size products

Type: Flush grid plastic modular

Code : **FG2540-04**

| Specification | |
|---------------------------|-----------------------|
| Pitch P | 25.4 mm |
| Thickness T | 9.8 mm |
| Pin Dia. D | 5.2 mm |
| Weight | 7.1 kg/m ² |
| Material | POM |
| Color | Blue / White |
| Open area | 35% |
| Permissible tensile force | 21000 N/m |
| Pin material | PP(PA) |
| Counter flection | 35.0 mm |
| Running radius | - |
| Characteristic | FDA |
| Temperature | -40~93 °C |

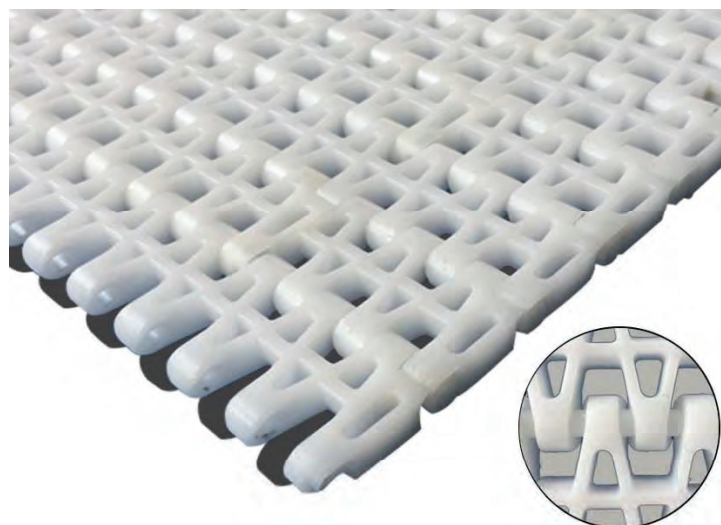

Belt Width=50 mm * N

| | | | | | | | | | |
|------|------|------|------|------|------|------|------|------|------|
| 50 | 100 | 150 | 200 | 250 | 300 | 350 | 400 | 450 | 500 |
| 550 | 600 | 650 | 700 | 750 | 800 | 850 | 900 | 950 | 1000 |
| 1050 | 1100 | 1150 | 1200 | 1250 | 1300 | 1350 | 1400 | 1450 | 1500 |
| 1550 | 1600 | 1650 | 1700 | 1750 | 1800 | 1850 | 1900 | 1950 | 2000 |

Sprocket

| | |
|------------------|----------------|
| Tooth Z | 12/20 |
| Bore S | 40.0 mm |
| Diameter Ø | 100.0/165.0 mm |
| Tooth width d | 6.0 mm |
| Sprocket width D | 30.0 mm |
| Material | PA |
| Color | Natural |

Application

Food, beverages and other industrial that handle small-medium size products

Type: Flat top plastic modular

Code : FT2540-05B

| Specification | |
|---------------------------|-----------------------|
| Pitch P | 25.4 mm |
| Thickness T | 12.7 mm |
| Pin Dia. D | 6.3 mm |
| Weight | 8.6 kg/m ² |
| Material | PP |
| Color | Grey |
| Open area | - |
| Permissible tensile force | 21000 N/m |
| Pin material | PP(PA) |
| Counter flection | 35.0 mm |
| Running radius | - |
| Characteristic | FDA |
| Temperature | 0~104 °C |



Belt Width=50.8 mm * N

| | | | | | | | | | |
|--------|--------|------|--------|--------|--------|--------|------|--------|--------|
| 152.4 | 203.2 | 254 | 304.8 | 355.6 | 406.4 | 457.2 | 508 | 558.8 | 609.6 |
| 660.4 | 711.2 | 762 | 812.8 | 863.6 | 914.4 | 965.2 | 1016 | 1066.8 | 1117.6 |
| 1168.4 | 1219.2 | 1270 | 1320.8 | 1371.6 | 1422.4 | 1473.2 | 1524 | 1574.8 | 1625.6 |
| 1676.4 | 1727.2 | 1778 | 1828.8 | 1879.6 | 1930.4 | 1981.2 | 2032 | 2082.8 | 2133.6 |

Sprocket

| | |
|------------------|----------|
| Tooth Z | 10 |
| Bore S | 60.0 mm |
| Diameter Ø | 146.0 mm |
| Tooth width d | 14.8 mm |
| Sprocket width D | 38.0 mm |
| Material | PA |
| Color | Black |

Application

Tyre, logistic and other industrial that handle small-medium size products

Type: Flush grid plastic modular

Code : FG2540-05

| Specification | |
|---------------------------|-----------------------|
| Pitch P | 25.4 mm |
| Thickness T | 8.7 mm |
| Pin Dia. D | 5.2 mm |
| Weight | 6.3 kg/m ² |
| Material | POM |
| Color | White / Blue |
| Open area | 34% |
| Permissible tensile force | 21000 N/m |
| Pin material | PP(PA) |
| Counter flection | 35.0 mm |
| Running radius | - |
| Characteristic | FDA |
| Temperature | -40~93 °C |

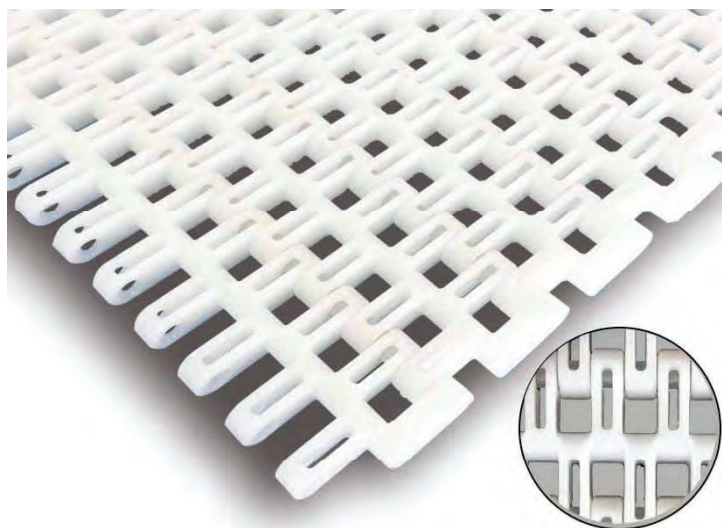

Belt Width=304.8+50.8 mm * N

| | | | | | | | | | |
|--------|--------|--------|--------|------|--------|--------|--------|--------|------|
| 304.8 | 355.6 | 406.4 | 457.2 | 508 | 558.8 | 609.6 | 660.4 | 711.2 | 762 |
| 812.8 | 863.6 | 914.4 | 965.2 | 1016 | 1066.8 | 1117.6 | 1168.4 | 1219.2 | 1270 |
| 1320.8 | 1371.6 | 1422.4 | 1473.2 | 1524 | 1574.8 | 1625.6 | 1676.4 | 1727.2 | 1778 |
| 1828.8 | 1879.6 | 1930.4 | 1981.2 | 2032 | 2082.8 | 2133.6 | 2184.4 | 2235.2 | 2286 |

Sprocket

| | |
|------------------|----------|
| Tooth Z | 19 |
| Bore S | 60.0 mm |
| Diameter Ø | 160.0 mm |
| Tooth width d | 6.5 mm |
| Sprocket width D | 36.0 mm |
| Material | POM |
| Color | Natural |

Application

Food, beverages, Dairy, pharmacy, cosmetics and other industrial that handle small-medium size products

Type: Low back pressure plastic modular

Code : LBP2540-05

| Specification | |
|---------------------------|------------------------|
| Pitch P | 25.4 mm |
| Thickness T | 12.7 mm |
| Pin Dia. D | 6.3 mm |
| Weight | 28.5 kg/m ² |
| Material | POM |
| Color | Grey |
| Open area | - |
| Permissible tensile force | 30000 N/m |
| Pin material | PP(PA) |
| Counter flection | 70.0 mm |
| Running radius | - |
| Characteristic | FDA |
| Temperature | -40~93 °C |



Belt Width=152.4+50.8 mm * N

| | | | | | | | | | |
|--------|--------|------|--------|--------|--------|--------|------|--------|--------|
| 152.4 | 203.2 | 254 | 304.8 | 355.6 | 406.4 | 457.2 | 508 | 558.8 | 609.6 |
| 660.4 | 711.2 | 762 | 812.8 | 863.6 | 914.4 | 965.2 | 1016 | 1066.8 | 1117.6 |
| 1168.4 | 1219.2 | 1270 | 1320.8 | 1371.6 | 1422.4 | 1473.2 | 1524 | 1574.8 | 1625.6 |
| 1676.4 | 1727.2 | 1778 | 1828.8 | 1879.6 | 1930.4 | 1981.2 | 2032 | 2082.8 | 2133.6 |

Sprocket

| | |
|------------------|----------|
| Tooth Z | 10 |
| Bore S | 60.0 mm |
| Diameter Ø | 146.0 mm |
| Tooth width d | 14.8 mm |
| Sprocket width D | 38.0 mm |
| Material | PA |
| Color | Black |

Application

Tyre, logistic and other industrial that handle small-medium size products

Type: Flat top plastic modular

Code : FT2540-06

| Specification | |
|---------------------------|-----------------------|
| Pitch P | 25.4 mm |
| Thickness T | 12.7 mm |
| Pin Dia. D | 5.2 mm |
| Weight | 8.5 kg/m ² |
| Material | POM |
| Color | Yellow / Dark blue |
| Open area | - |
| Permissible tensile force | 28000 N/m |
| Pin material | PP(PA) |
| Counter flection | 35.0 mm |
| Running radius | - |
| Characteristic | FDA |
| Temperature | 0~104 °C |

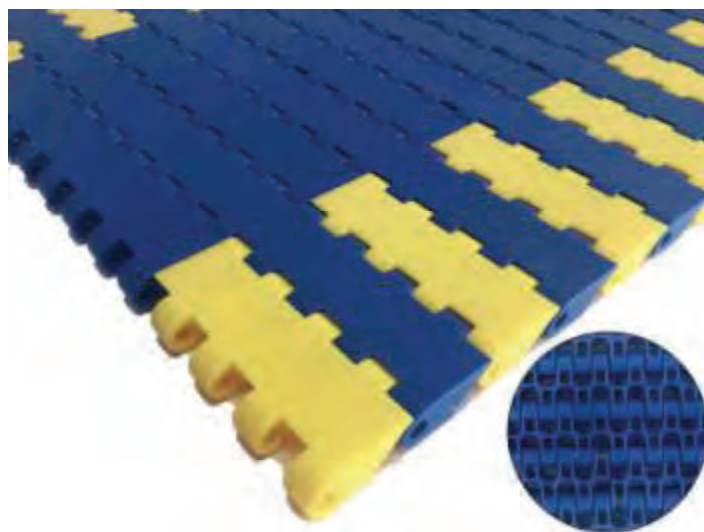

Belt Width=75 mm * N

| | | | | | | | | | |
|------|------|------|------|------|------|------|------|------|------|
| 75 | 150 | 225 | 300 | 375 | 450 | 525 | 600 | 675 | 750 |
| 825 | 900 | 975 | 1050 | 1125 | 1200 | 1275 | 1350 | 1425 | 1500 |
| 1575 | 1650 | 1725 | 1800 | 1875 | 1950 | 2025 | 2100 | 2175 | 2250 |
| 2325 | 2400 | 2475 | 2550 | 2625 | 2700 | 2775 | 2850 | 2925 | 3000 |

Sprocket

| | |
|------------------|------------|
| Tooth Z | 12/18 |
| Bore S | 40.0 mm |
| Diameter Ø | 102/150 mm |
| Tooth width d | 6.0 mm |
| Sprocket width D | 35.0 mm |
| Material | POM(PA) |
| Color | Natural |

Application

Corrugated paper, logistic and other industrial that handle small-medium size products

Type: Dynamic transfer plastic modular

Code : FT2540-07 DTS

| Specification | |
|---------------------------|-------------------------|
| Pitch P | 25.4 mm |
| Thickness T | 12.7 mm |
| Pin Dia. D | 6.4 mm |
| Weight | 13.47 kg/m ² |
| Material | POM |
| Color | Dark green |
| Open area | - |
| Permissible tensile force | 43000 N/m |
| Pin material | PP(PA) |
| Counter flection | 25.0 mm |
| Running radius | - |
| Characteristic | FDA |
| Temperature | -40~93 °C |



Belt Width=127 mm

| | | | | | | | | | |
|--|--|--|--|--|--|--|--|--|--|
| | | | | | | | | | |
| | | | | | | | | | |
| | | | | | | | | | |
| | | | | | | | | | |

Sprocket

| | |
|------------------|---------|
| Tooth Z | 24 |
| Bore R | 30.0 mm |
| Diameter Ø | 93.0 mm |
| Tooth width d | 8.0 mm |
| Sprocket width D | 38.0 mm |
| Material | PA |
| Color | Natural |

Application

Food, poultry and other industrial that handle small-medium size products

Type: Side flexing plastic modular

Code : SF2540-21

| Specification | |
|---------------------------|------------------------|
| Pitch P | 25.4 mm |
| Thickness T | 12.7 mm |
| Pin Dia. D | 4.8 mm |
| Weight | 10.6 kg/m ² |
| Material | POM |
| Color | Natural / Blue |
| Open area | 55% |
| Permissible tensile force | 19000 N/m |
| Pin material | PP(PA) |
| Counter flection | 35.0 mm |
| Running radius | Belt width *2.5 |
| Characteristic | FDA |
| Temperature | -40~93°C |



Belt Width=152.4+50.8 mm * N

| | | | | | | | | | |
|--------|--------|------|--------|--------|--------|--------|------|--------|--------|
| 152.4 | 203.2 | 254 | 304.8 | 355.6 | 406.4 | 457.2 | 508 | 558.8 | 609.6 |
| 660.4 | 711.2 | 762 | 812.8 | 863.6 | 914.4 | 965.2 | 1016 | 1066.8 | 1117.6 |
| 1168.4 | 1219.2 | 1270 | 1320.8 | 1371.6 | 1422.4 | 1473.2 | 1524 | 1574.8 | 1625.6 |
| 1676.4 | 1727.2 | 1778 | 1828.8 | 1879.6 | 1930.4 | 1981.2 | 2032 | 2082.8 | 2133.6 |

Sprocket

| | |
|------------------|----------|
| Tooth Z | 15 |
| Bore S | 30.0 mm |
| Diameter Ø | 123.5 mm |
| Tooth width d | 5.0 mm |
| Sprocket width D | 38.0 mm |
| Material | PA |
| Color | Natural |

Application

Food, beverages, dairy, pharmacy, cosmetics and other industrial that handle small-medium size products

Type: Flat top plastic modular

Code : FT2720-01

| Specification | |
|---------------------------|-----------------------|
| Pitch P | 27.2 mm |
| Thickness T | 9.8 mm |
| Pin Dia. D | 4.8 mm |
| Weight | 7.3 kg/m ² |
| Material | POM |
| Color | Blue |
| Open area | - |
| Permissible tensile force | 23000 N/m |
| Pin material | PP(PA) |
| Counter flection | 40.0 mm |
| Running radius | - |
| Characteristic | FDA |
| Temperature | -40~93 °C |

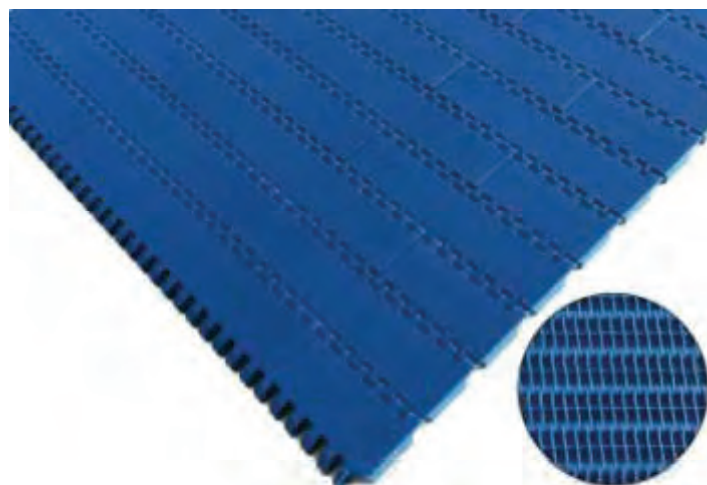

Belt Width=152.4+50.8 mm * N

| | | | | | | | | | |
|--------|--------|------|--------|--------|--------|--------|------|--------|--------|
| 152.4 | 203.2 | 254 | 304.8 | 355.6 | 406.4 | 457.2 | 508 | 558.8 | 609.6 |
| 660.4 | 711.2 | 762 | 812.8 | 863.6 | 914.4 | 965.2 | 1016 | 1066.8 | 1117.6 |
| 1168.4 | 1219.2 | 1270 | 1320.8 | 1371.6 | 1422.4 | 1473.2 | 1524 | 1574.8 | 1625.6 |
| 1676.4 | 1727.2 | 1778 | 1828.8 | 1879.6 | 1930.4 | 1981.2 | 2032 | 2082.8 | 2133.6 |

Sprocket

| | |
|------------------|----------------|
| Tooth Z | 12/18 |
| Bore S | 30.0/50.0 mm |
| Diameter Ø | 108.2/160.3 mm |
| Tooth width d | 4.3 mm |
| Sprocket width D | 40.0 mm |
| Material | POM |
| Color | Natural |

Application

Tyre, food, beverages and other industrial that handle small-medium size products

Type: Flush grid plastic modular

Code : FG2720-01

| Specification | |
|---------------------------|-----------------------|
| Pitch P | 27.2 mm |
| Thickness T | 8.7 mm |
| Pin Dia. D | 4.8 mm |
| Weight | 5.6 kg/m ² |
| Material | POM |
| Color | Blue |
| Open area | 37% |
| Permissible tensile force | 22000 N/m |
| Pin material | PP(PA) |
| Counter flection | 40.0 mm |
| Running radius | - |
| Characteristic | FDA |
| Temperature | -40~93 °C |

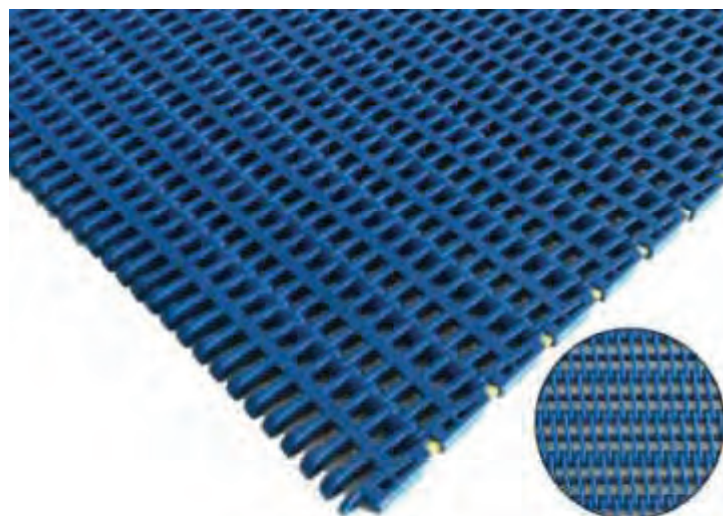

Belt Width=152.4+50.8 mm * N

| | | | | | | | | | |
|--------|--------|------|--------|--------|--------|--------|------|--------|--------|
| 152.4 | 203.2 | 254 | 304.8 | 355.6 | 406.4 | 457.2 | 508 | 558.8 | 609.6 |
| 660.4 | 711.2 | 762 | 812.8 | 863.6 | 914.4 | 965.2 | 1016 | 1066.8 | 1117.6 |
| 1168.4 | 1219.2 | 1270 | 1320.8 | 1371.6 | 1422.4 | 1473.2 | 1524 | 1574.8 | 1625.6 |
| 1676.4 | 1727.2 | 1778 | 1828.8 | 1879.6 | 1930.4 | 1981.2 | 2032 | 2082.8 | 2133.6 |

Sprocket

| | |
|------------------|----------------|
| Tooth Z | 12/18 |
| Bore S | 30.0/50.0 mm |
| Diameter Ø | 108.2/160.3 mm |
| Tooth width d | 4.3 mm |
| Sprocket width D | 40.0 mm |
| Material | POM |
| Color | Natural |

Application

Tyre, food, beverages and other industrial that handle small-medium size products

Type: Flat top plastic modular

Code : SG2720-01

| Specification | |
|---------------------------|-----------------------|
| Pitch P | 27.2 mm |
| Thickness T | 9.8 mm |
| Pin Dia. D | 4.8 mm |
| Weight | 8.3 kg/m ² |
| Material | POM |
| Color | Black |
| Open area | - |
| Permissible tensile force | 23000 N/m |
| Pin material | PP(PA) |
| Counter flection | 40.0 mm |
| Running radius | - |
| Characteristic | FDA |
| Temperature | -40~93 °C |



Belt Width=304.8+50.8 mm * N

| | | | | | | | | | |
|--------|--------|--------|--------|------|--------|--------|--------|--------|------|
| 304.8 | 355.6 | 406.4 | 457.2 | 508 | 558.8 | 609.6 | 660.4 | 711.2 | 762 |
| 812.8 | 863.6 | 914.4 | 965.2 | 1016 | 1066.8 | 1117.6 | 1168.4 | 1219.2 | 1270 |
| 1320.8 | 1371.6 | 1422.4 | 1473.2 | 1524 | 1574.8 | 1625.6 | 1676.4 | 1727.2 | 1778 |
| 1828.8 | 1879.6 | 1930.4 | 1981.2 | 2032 | 2082.8 | 2133.6 | 2184.4 | 2235.2 | 2286 |

Sprocket

| | |
|------------------|----------------|
| Tooth Z | 12/18 |
| Bore S | 30.0/50.0 mm |
| Diameter Ø | 108.2/160.3 mm |
| Tooth width d | 4.3 mm |
| Sprocket width D | 40.0 mm |
| Material | POM |
| Color | Natural |

Application

Food, beverages and other industrial that handle small-medium size products

Type: Raised rib plastic modular

Code : RR2720-01

| Specification | |
|---------------------------|-----------------------|
| Pitch P | 27.2 mm |
| Thickness T | 14.0 mm |
| Pin Dia. D | 4.8 mm |
| Weight | 8.2 kg/m ² |
| Material | POM |
| Color | Blue |
| Open area | 37% |
| Permissible tensile force | 22000 N/m |
| Pin material | PP(PA) |
| Counter flection | 40.0 mm |
| Running radius | - |
| Characteristic | FDA |
| Temperature | -40~93 °C |

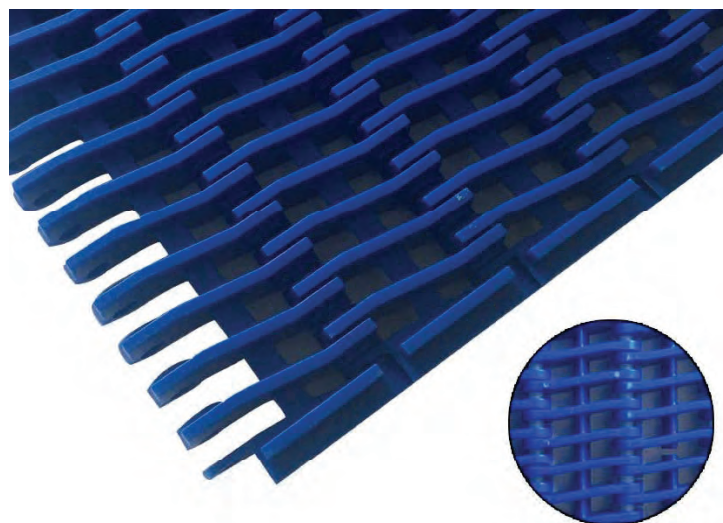

Belt Width=152.4+50.8 mm * N

| | | | | | | | | | |
|--------|--------|------|--------|--------|--------|--------|------|--------|--------|
| 152.4 | 203.2 | 254 | 304.8 | 355.6 | 406.4 | 457.2 | 508 | 558.8 | 609.6 |
| 660.4 | 711.2 | 762 | 812.8 | 863.6 | 914.4 | 965.2 | 1016 | 1066.8 | 1117.6 |
| 1168.4 | 1219.2 | 1270 | 1320.8 | 1371.6 | 1422.4 | 1473.2 | 1524 | 1574.8 | 1625.6 |
| 1676.4 | 1727.2 | 1778 | 1828.8 | 1879.6 | 1930.4 | 1981.2 | 2032 | 2082.8 | 2133.6 |

Sprocket

| | |
|------------------|----------------|
| Tooth Z | 12/18 |
| Bore S | 30.0/50.0 mm |
| Diameter Ø | 108.2/160.3 mm |
| Tooth width d | 4.3 mm |
| Sprocket width D | 40.0 mm |
| Material | POM |
| Color | Natural |

Application

Food, beverages and other industrial that handle small-medium size products

Type: Flush grid plastic modular

Code : FG2720-02

| Specification | |
|---------------------------|-----------------------|
| Pitch P | 27.2 mm |
| Thickness T | 8.7 mm |
| Pin Dia. D | 4.8 mm |
| Weight | 5.8 kg/m ² |
| Material | POM |
| Color | 蓝色 |
| Open area | 40% |
| Permissible tensile force | 21000 N/m |
| Pin material | PP(PA) |
| Counter flection | 40.0 mm |
| Running radius | - |
| Characteristic | FDA |
| Temperature | -40~93 °C |



Belt Width=152.4+50.8 mm * N

| | | | | | | | | | |
|--------|--------|------|--------|--------|--------|--------|------|--------|--------|
| 152.4 | 203.2 | 254 | 304.8 | 355.6 | 406.4 | 457.2 | 508 | 558.8 | 609.6 |
| 660.4 | 711.2 | 762 | 812.8 | 863.6 | 914.4 | 965.2 | 1016 | 1066.8 | 1117.6 |
| 1168.4 | 1219.2 | 1270 | 1320.8 | 1371.6 | 1422.4 | 1473.2 | 1524 | 1574.8 | 1625.6 |
| 1676.4 | 1727.2 | 1778 | 1828.8 | 1879.6 | 1930.4 | 1981.2 | 2032 | 2082.8 | 2133.6 |

Sprocket

| | |
|------------------|----------|
| Tooth Z | 18 |
| Bore S | 40.0 mm |
| Diameter Ø | 160.3 mm |
| Tooth width d | 4.3 mm |
| Sprocket width D | 40.0 mm |
| Material | POM |
| Color | Natural |

Application

Tyre and other industrial that handle small-medium size products

Type: Flush grid plastic modular

Code : FG3810-01

| Specification | |
|---------------------------|-----------------------|
| Pitch P | 38.1 mm |
| Thickness T | 19.0 mm |
| Pin Dia. D | 8.3 mm |
| Weight | 9.5 kg/m ² |
| Material | PP |
| Color | Grey |
| Open area | 37% |
| Permissible tensile force | 23000 N/m |
| Pin material | PP(PA) |
| Counter flection | 38.0 mm |
| Running radius | - |
| Characteristic | FDA |
| Temperature | 0~104 °C |



Belt Width=304.8+50.8 mm * N

| | | | | | | | | | |
|--------|--------|--------|--------|------|--------|--------|--------|--------|------|
| 304.8 | 355.6 | 406.4 | 457.2 | 508 | 558.8 | 609.6 | 660.4 | 711.2 | 762 |
| 812.8 | 863.6 | 914.4 | 965.2 | 1016 | 1066.8 | 1117.6 | 1168.4 | 1219.2 | 1270 |
| 1320.8 | 1371.6 | 1422.4 | 1473.2 | 1524 | 1574.8 | 1625.6 | 1676.4 | 1727.2 | 1778 |
| 1828.8 | 1879.6 | 1930.4 | 1981.2 | 2032 | 2082.8 | 2133.6 | 2184.4 | 2235.2 | 2286 |

Sprocket

| | |
|------------------|----------|
| Tooth Z | 12 |
| Bore S | 40.0 mm |
| Diameter Ø | 155.0 mm |
| Tooth width d | 11.2 mm |
| Sprocket width D | 38.0 mm |
| Material | PA |
| Color | Natural |

Application

Food, beverages, Dairy, pharmacy, cosmetics and other industrial that handle small-medium size products

Type: Flush grid plastic modular

Code : SG4000-01

| Specification | |
|---------------------------|-----------------------|
| Pitch P | 40.0 mm |
| Thickness T | 12.5 mm |
| Pin Dia. D | 6.3 mm |
| Weight | 6.8 kg/m ² |
| Material | PP |
| Color | Purple |
| Open area | 40% |
| Permissible tensile force | 23000 N/m |
| Pin material | PP(PA) |
| Counter flection | 40.0 mm |
| Running radius | - |
| Characteristic | FDA |
| Temperature | 0~104 °C |

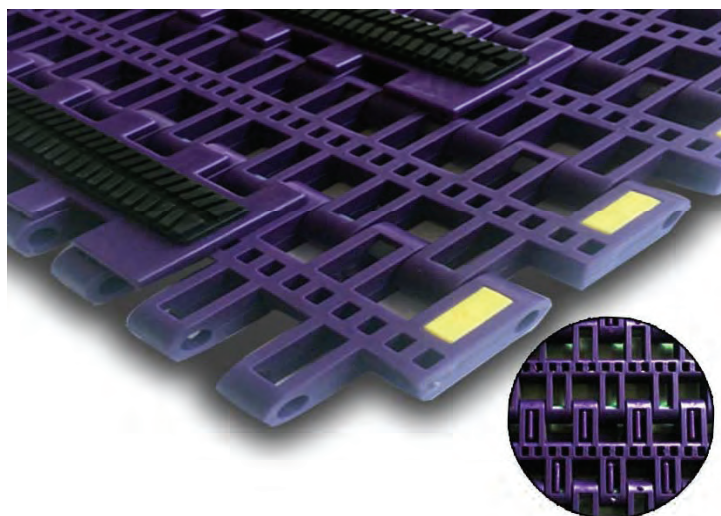

Belt Width=200+50 mm * N

| | | | | | | | | | |
|------|------|------|------|------|------|------|------|------|------|
| 200 | 250 | 300 | 350 | 400 | 450 | 500 | 550 | 600 | 650 |
| 700 | 750 | 800 | 850 | 900 | 950 | 1000 | 1050 | 1100 | 1150 |
| 1200 | 1250 | 1300 | 1350 | 1400 | 1450 | 1500 | 1550 | 1600 | 1650 |
| 1700 | 1750 | 1800 | 1850 | 1900 | 1950 | 2000 | 2050 | 2100 | 2150 |

Sprocket

| | |
|------------------|----------|
| Tooth Z | 24 |
| Bore S | 60.0 mm |
| Diameter Ø | 189.0 mm |
| Tooth width d | 12.5 mm |
| Sprocket width D | 37.0 mm |
| Material | PA |
| Color | Natural |

Application

Food, Tyre and other industrial that handle small-medium size products

Type: Side flexing plastic modular

Code : SF5080-01

| Specification | |
|---------------------------|-----------------------|
| Pitch P | 50.8 mm |
| Thickness T | 15.0 mm |
| Pin Dia. D | 6.3 mm |
| Weight | 8.7 kg/m ² |
| Material | POM |
| Color | Blue / White |
| Open area | 48% |
| Permissible tensile force | 22000 N/m |
| Pin material | PP(PA) |
| Counter flection | 45.0 mm |
| Running radius | Belt width *2.5 |
| Characteristic | FDA |
| Temperature | -40~93 °C |

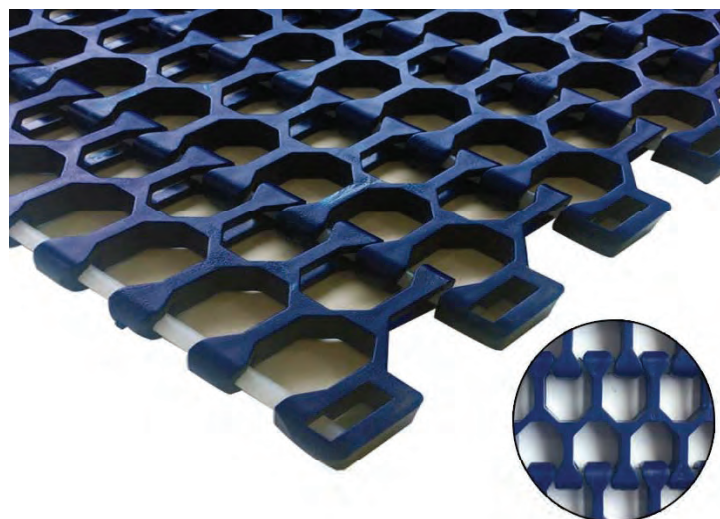

Belt Width=304.8+50.8 mm * N

| | | | | | | | | | |
|--------|--------|--------|--------|------|--------|--------|--------|--------|------|
| 304.8 | 355.6 | 406.4 | 457.2 | 508 | 558.8 | 609.6 | 660.4 | 711.2 | 762 |
| 812.8 | 863.6 | 914.4 | 965.2 | 1016 | 1066.8 | 1117.6 | 1168.4 | 1219.2 | 1270 |
| 1320.8 | 1371.6 | 1422.4 | 1473.2 | 1524 | 1574.8 | 1625.6 | 1676.4 | 1727.2 | 1778 |
| 1828.8 | 1879.6 | 1930.4 | 1981.2 | 2032 | 2082.8 | 2133.6 | 2184.4 | 2235.2 | 2286 |

Sprocket

| | |
|------------------|----------|
| Tooth Z | 10 |
| Bore R | 50.0 mm |
| Diameter Ø | 164.0 mm |
| Tooth width d | 9.2 mm |
| Sprocket width D | 50.0 mm |
| Material | POM |
| Color | Natural |

Application

Food and other industrial that handle small-medium size products

Type: Side flexing plastic modular

Code : SF5080-02

| Specification | |
|---------------------------|-----------------------|
| Pitch P | 50.8 mm |
| Thickness T | 19.05 mm |
| Pin Dia. D | 6.3 mm |
| Weight | 6.1 kg/m ² |
| Material | PP |
| Color | Blue / White |
| Open area | 46% |
| Permissible tensile force | 22000 N/m |
| Pin material | PP(PA) |
| Counter flection | 50.0 mm |
| Running radius | Belt width *2.5 |
| Characteristic | FDA |
| Temperature | 0~104 °C |

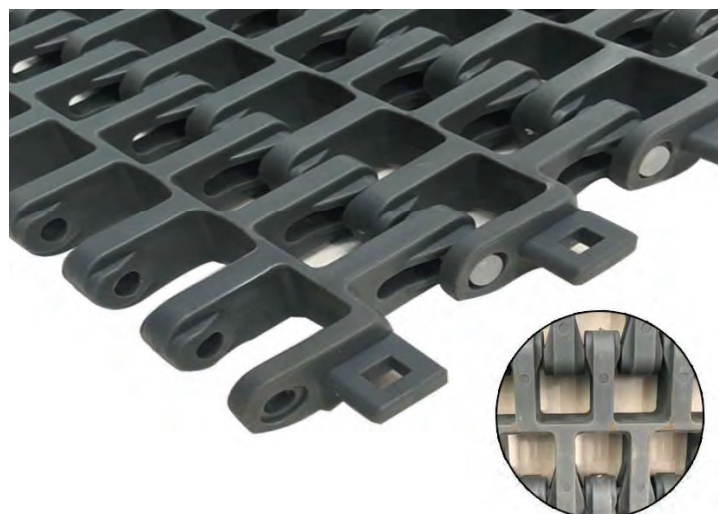

Belt Width=304.8+50.8 mm * N

| | | | | | | | | | |
|--------|--------|--------|--------|------|--------|--------|--------|--------|------|
| 304.8 | 355.6 | 406.4 | 457.2 | 508 | 558.8 | 609.6 | 660.4 | 711.2 | 762 |
| 812.8 | 863.6 | 914.4 | 965.2 | 1016 | 1066.8 | 1117.6 | 1168.4 | 1219.2 | 1270 |
| 1320.8 | 1371.6 | 1422.4 | 1473.2 | 1524 | 1574.8 | 1625.6 | 1676.4 | 1727.2 | 1778 |
| 1828.8 | 1879.6 | 1930.4 | 1981.2 | 2032 | 2082.8 | 2133.6 | 2184.4 | 2235.2 | 2286 |

Sprocket

| | |
|------------------|----------|
| Tooth Z | 10 |
| Bore S | 40.0 mm |
| Diameter Ø | 173.0 mm |
| Tooth width d | 12.5mm |
| Sprocket width D | 38.0 mm |
| Material | PA |
| Color | Natural |

Application

Food and other industrial that handle small-medium size products

Type: Raised rib plastic modular

Code : RR5080-02

| Specification | |
|---------------------------|-----------------------|
| Pitch P | 50.8 mm |
| Thickness T | 22.0 mm |
| Pin Dia. D | 6.3 mm |
| Weight | 9.5 kg/m ² |
| Material | PP |
| Color | Tan |
| Open area | 36% |
| Permissible tensile force | 25000 N/m |
| Pin material | PP(PA) |
| Counter flection | 45.0 mm |
| Running radius | - |
| Characteristic | FDA |
| Temperature | 0~104 °C |

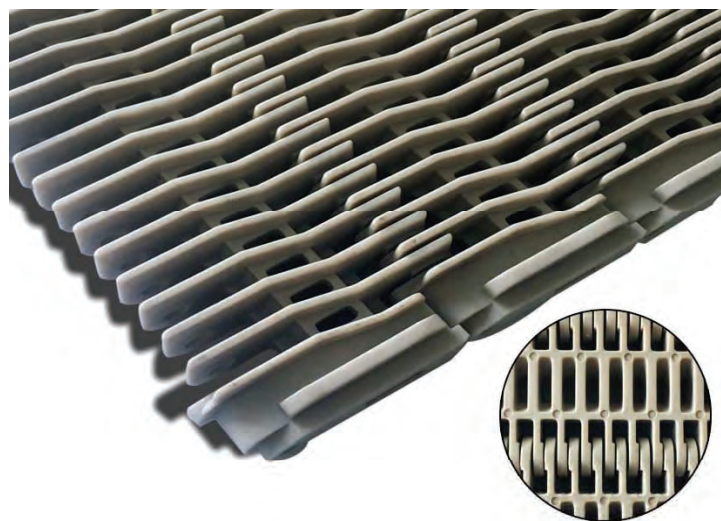

Belt Width=254+50.8 mm * N

| | | | | | | | | | |
|--------|--------|--------|--------|------|--------|--------|--------|--------|------|
| 254 | 355.6 | 406.4 | 457.2 | 508 | 558.8 | 609.6 | 660.4 | 711.2 | 762 |
| 812.8 | 863.6 | 914.4 | 965.2 | 1016 | 1066.8 | 1117.6 | 1168.4 | 1219.2 | 1270 |
| 1320.8 | 1371.6 | 1422.4 | 1473.2 | 1524 | 1574.8 | 1625.6 | 1676.4 | 1727.2 | 1778 |
| 1828.8 | 1879.6 | 1930.4 | 1981.2 | 2032 | 2082.8 | 2133.6 | 2184.4 | 2235.2 | 2286 |

Sprocket

| | |
|------------------|----------|
| Tooth Z | 10 |
| Bore S | 60.0 mm |
| Diameter Ø | 157.0 mm |
| Tooth width d | 4.8 mm |
| Sprocket width D | 35.0 mm |
| Material | POM |
| Color | Natural |

Application

Food, beverages and other industrial that handle small-medium size products

Type: Low back pressure plastic modular

Code : LBP5080-02A

| Specification | |
|---------------------------|------------------------|
| Pitch P | 50.8 mm |
| Thickness T | 16.0 mm |
| Pin Dia. D | 6.3 mm |
| Weight | 12.1 kg/m ² |
| Material | PP |
| Color | Grey |
| Open area | 18% |
| Permissible tensile force | 25000 N/m |
| Pin material | PP(PA) |
| Counter flection | 45.0 mm |
| Running radius | - |
| Characteristic | FDA |
| Temperature | 0~104 °C |

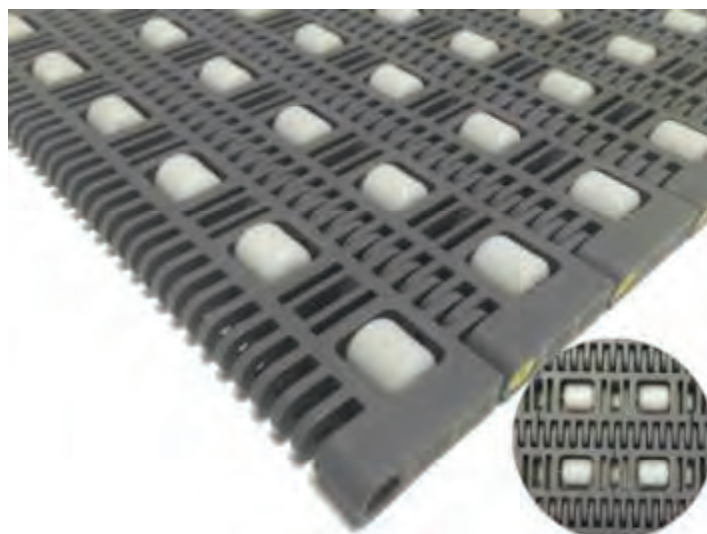

Belt Width=254+50.8 mm * N

| | | | | | | | | | |
|--------|--------|--------|--------|------|--------|--------|--------|--------|------|
| 254 | 355.6 | 406.4 | 457.2 | 508 | 558.8 | 609.6 | 660.4 | 711.2 | 762 |
| 812.8 | 863.6 | 914.4 | 965.2 | 1016 | 1066.8 | 1117.6 | 1168.4 | 1219.2 | 1270 |
| 1320.8 | 1371.6 | 1422.4 | 1473.2 | 1524 | 1574.8 | 1625.6 | 1676.4 | 1727.2 | 1778 |
| 1828.8 | 1879.6 | 1930.4 | 1981.2 | 2032 | 2082.8 | 2133.6 | 2184.4 | 2235.2 | 2286 |

Sprocket

| | |
|------------------|----------|
| Tooth Z | 10 |
| Bore S | 60.0 mm |
| Diameter Ø | 157.0 mm |
| Tooth width d | 4.8 mm |
| Sprocket width D | 35.0 mm |
| Material | POM |
| Color | Natural |

Application

Tyre, logistic and other industrial that handle small-medium size products

Type: Low back pressure plastic modular

Code : LBP5080-02B

| Specification | |
|---------------------------|-----------------------|
| Pitch P | 50.8 mm |
| Thickness T | 16.0 mm |
| Pin Dia. D | 6.3 mm |
| Weight | 13.2kg/m ² |
| Material | PP |
| Color | Grey |
| Open area | 18% |
| Permissible tensile force | 25000 N/m |
| Pin material | PP(PA) |
| Counter flection | 45.0 mm |
| Running radius | - |
| Characteristic | FDA |
| Temperature | 0~104 °C |



Belt Width=254+50.8 mm * N

| | | | | | | | | | |
|--------|--------|--------|--------|------|--------|--------|--------|--------|------|
| 254 | 355.6 | 406.4 | 457.2 | 508 | 558.8 | 609.6 | 660.4 | 711.2 | 762 |
| 812.8 | 863.6 | 914.4 | 965.2 | 1016 | 1066.8 | 1117.6 | 1168.4 | 1219.2 | 1270 |
| 1320.8 | 1371.6 | 1422.4 | 1473.2 | 1524 | 1574.8 | 1625.6 | 1676.4 | 1727.2 | 1778 |
| 1828.8 | 1879.6 | 1930.4 | 1981.2 | 2032 | 2082.8 | 2133.6 | 2184.4 | 2235.2 | 2286 |

Sprocket

| | |
|------------------|----------|
| Tooth Z | 10 |
| Bore S | 60.0 mm |
| Diameter Ø | 164.0 mm |
| Tooth width d | 11.5 mm |
| Sprocket width D | 42.0 mm |
| Material | PA |
| Color | Natural |

Application

Tyre, logistic and other industrial that handle small-medium size products

Type: Low back pressure plastic modular

Code : LBP5080-02C

| Specification | |
|---------------------------|------------------------|
| Pitch P | 50.8 mm |
| Thickness T | 16.0 mm |
| Pin Dia. D | 6.3 mm |
| Weight | 12.9 kg/m ² |
| Material | PP |
| Color | Grey |
| Open area | 15% |
| Permissible tensile force | 25000 N/m |
| Pin material | PP(PA) |
| Counter flection | 45.0 mm |
| Running radius | - |
| Characteristic | FDA |
| Temperature | 0~104 °C |



Belt Width=254+50.8 mm * N

| | | | | | | | | | |
|--------|--------|--------|--------|------|--------|--------|--------|--------|------|
| 254 | 355.6 | 406.4 | 457.2 | 508 | 558.8 | 609.6 | 660.4 | 711.2 | 762 |
| 812.8 | 863.6 | 914.4 | 965.2 | 1016 | 1066.8 | 1117.6 | 1168.4 | 1219.2 | 1270 |
| 1320.8 | 1371.6 | 1422.4 | 1473.2 | 1524 | 1574.8 | 1625.6 | 1676.4 | 1727.2 | 1778 |
| 1828.8 | 1879.6 | 1930.4 | 1981.2 | 2032 | 2082.8 | 2133.6 | 2184.4 | 2235.2 | 2286 |

Sprocket

| | |
|------------------|----------|
| Tooth Z | 10 |
| Bore S | 60.0 mm |
| Diameter Ø | 164.0 mm |
| Tooth width d | 11.5 mm |
| Sprocket width D | 42.0 mm |
| Material | PA |
| Color | Natural |

Application

Tyre, logistic and other industrial that handle small-medium size products

Type: Low back pressure plastic modular

Code : **LBP5080-02D**

| Specification | |
|---------------------------|------------------------|
| Pitch P | 50.8 mm |
| Thickness T | 16.0 mm |
| Pin Dia. D | 6.3 mm |
| Weight | 13.8 kg/m ² |
| Material | PP |
| Color | Grey |
| Open area | 18% |
| Permissible tensile force | 25000 N/m |
| Pin material | PP(PA) |
| Counter flection | 45.0 mm |
| Running radius | - |
| Characteristic | FDA |
| Temperature | 0~104 °C |



Belt Width=254+50.8 mm * N

| | | | | | | | | | |
|--------|--------|--------|--------|------|--------|--------|--------|--------|------|
| 254 | 355.6 | 406.4 | 457.2 | 508 | 558.8 | 609.6 | 660.4 | 711.2 | 762 |
| 812.8 | 863.6 | 914.4 | 965.2 | 1016 | 1066.8 | 1117.6 | 1168.4 | 1219.2 | 1270 |
| 1320.8 | 1371.6 | 1422.4 | 1473.2 | 1524 | 1574.8 | 1625.6 | 1676.4 | 1727.2 | 1778 |
| 1828.8 | 1879.6 | 1930.4 | 1981.2 | 2032 | 2082.8 | 2133.6 | 2184.4 | 2235.2 | 2286 |

Sprocket

| | |
|------------------|---------|
| Tooth Z | 10 |
| Bore S | 60.0 mm |
| Diameter Ø | 164 mm |
| Tooth width d | 11.5 mm |
| Sprocket width D | 42.0 mm |
| Material | PA |
| Color | Natural |

Application

Tyre, logistic and other industrial that handle small-medium size products

Type: Flat top plastic modular

Code : FT5080-03A

| Specification | |
|---------------------------|-----------------------|
| Pitch P | 50.8 mm |
| Thickness T | 16.0 mm |
| Pin Dia. D | 8.4 mm |
| Weight | 7.5 kg/m ² |
| Material | PP |
| Color | White |
| Open area | - |
| Permissible tensile force | 22000 N/m |
| Pin material | PP(PA) |
| Counter flection | 45.0 mm |
| Running radius | - |
| Characteristic | FDA |
| Temperature | 0~104 °C |

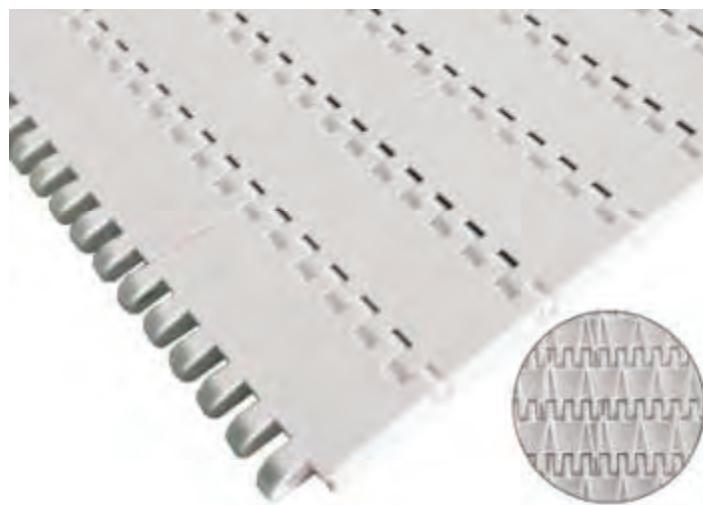

Belt Width=152.4+50.8 mm * N

| | | | | | | | | | |
|--------|--------|------|--------|--------|--------|--------|------|--------|--------|
| 152.4 | 203.2 | 254 | 304.8 | 355.6 | 406.4 | 457.2 | 508 | 558.8 | 609.6 |
| 660.4 | 711.2 | 762 | 812.8 | 863.6 | 914.4 | 965.2 | 1016 | 1066.8 | 1117.6 |
| 1168.4 | 1219.2 | 1270 | 1320.8 | 1371.6 | 1422.4 | 1473.2 | 1524 | 1574.8 | 1625.6 |
| 1676.4 | 1727.2 | 1778 | 1828.8 | 1879.6 | 1930.4 | 1981.2 | 2032 | 2082.8 | 2133.6 |

Sprocket

| | |
|------------------|----------|
| Tooth Z | 10 |
| Bore S | 50.0 mm |
| Diameter Ø | 161.4 mm |
| Tooth width d | 15.0 mm |
| Sprocket width D | 40.0 mm |
| Material | POM |
| Color | White |

Application

Food, poultry, logistic and other industrial that handle small-medium size products

Type: Flush grid plastic modular

Code : FG5080-03B

| Specification | |
|---------------------------|-----------------------|
| Pitch P | 50.8 mm |
| Thickness T | 16.0 mm |
| Pin Dia. D | 8.4 mm |
| Weight | 7.4 kg/m ² |
| Material | PP |
| Color | White |
| Open area | 12% |
| Permissible tensile force | 22000 N/m |
| Pin material | PP(PA) |
| Counter flection | 45.0 mm |
| Running radius | - |
| Characteristic | FDA |
| Temperature | 0~104 °C |

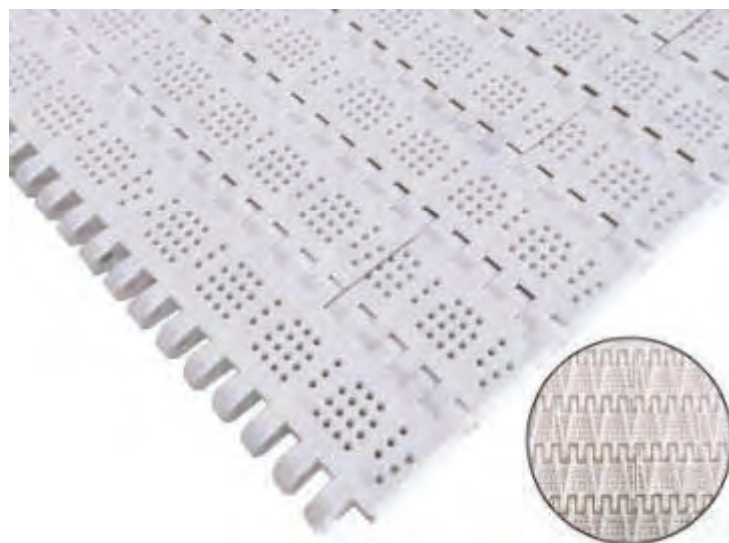

Belt Width=152.4+50.8 mm * N

| | | | | | | | | | |
|--------|--------|------|--------|--------|--------|--------|------|--------|--------|
| 152.4 | 203.2 | 254 | 304.8 | 355.6 | 406.4 | 457.2 | 508 | 558.8 | 609.6 |
| 660.4 | 711.2 | 762 | 812.8 | 863.6 | 914.4 | 965.2 | 1016 | 1066.8 | 1117.6 |
| 1168.4 | 1219.2 | 1270 | 1320.8 | 1371.6 | 1422.4 | 1473.2 | 1524 | 1574.8 | 1625.6 |
| 1676.4 | 1727.2 | 1778 | 1828.8 | 1879.6 | 1930.4 | 1981.2 | 2032 | 2082.8 | 2133.6 |

Sprocket

| | |
|------------------|----------|
| Tooth Z | 10 |
| Bore S | 50.0 mm |
| Diameter Ø | 161.4 mm |
| Tooth width d | 15.0 mm |
| Sprocket width D | 40.0 mm |
| Material | POM |
| Color | White |

Application

Food, poultry and other industrial that handle small-medium size products

Type: Flush grid plastic modular

Code : FG5080-03C

| Specification | |
|---------------------------|-----------------------|
| Pitch P | 50.8 mm |
| Thickness T | 16.0 mm |
| Pin Dia. D | 8.4 mm |
| Weight | 7.1 kg/m ² |
| Material | PP |
| Color | White |
| Open area | 23% |
| Permissible tensile force | 22000 N/m |
| Pin material | PP(PA) |
| Counter flection | 45.0 mm |
| Running radius | - |
| Characteristic | FDA |
| Temperature | 0~104 °C |

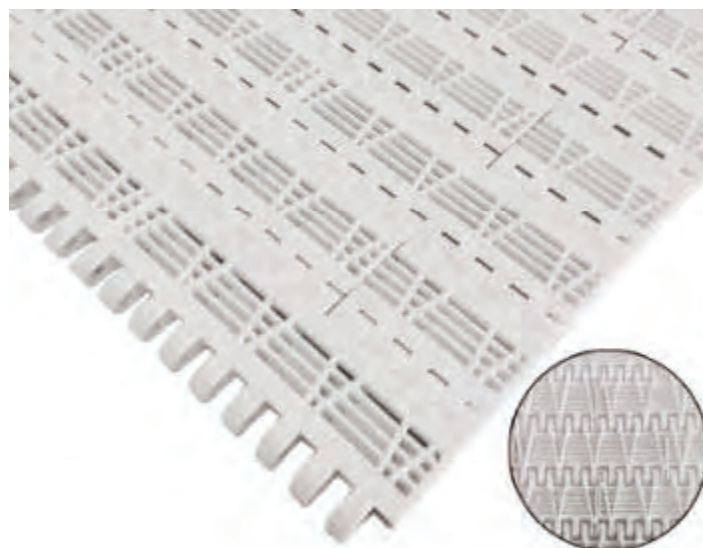

Belt Width=152.4+50.8 mm * N

| | | | | | | | | | |
|--------|--------|------|--------|--------|--------|--------|------|--------|--------|
| 152.4 | 203.2 | 254 | 304.8 | 355.6 | 406.4 | 457.2 | 508 | 558.8 | 609.6 |
| 660.4 | 711.2 | 762 | 812.8 | 863.6 | 914.4 | 965.2 | 1016 | 1066.8 | 1117.6 |
| 1168.4 | 1219.2 | 1270 | 1320.8 | 1371.6 | 1422.4 | 1473.2 | 1524 | 1574.8 | 1625.6 |
| 1676.4 | 1727.2 | 1778 | 1828.8 | 1879.6 | 1930.4 | 1981.2 | 2032 | 2082.8 | 2133.6 |

Sprocket

| | |
|------------------|----------|
| Tooth Z | 10 |
| Bore S | 50.0 mm |
| Diameter Ø | 161.4 mm |
| Tooth width d | 15.0 mm |
| Sprocket width D | 40.0 mm |
| Material | POM |
| Color | White |

Application

Food, poultry and other industrial that handle small-medium size products

Type: Flush grip plastic modular

Code : FG5080-03D

| Specification | |
|---------------------------|-----------------------|
| Pitch P | 50.8 mm |
| Thickness T | 16.0 mm |
| Pin Dia. D | 8.4 mm |
| Weight | 6.7 kg/m ² |
| Material | PP |
| Color | White |
| Open area | 40% |
| Permissible tensile force | 22000 N/m |
| Pin material | PP(PA) |
| Counter flection | 45.0 mm |
| Running radius | - |
| Characteristic | FDA |
| Temperature | 0~104 °C |

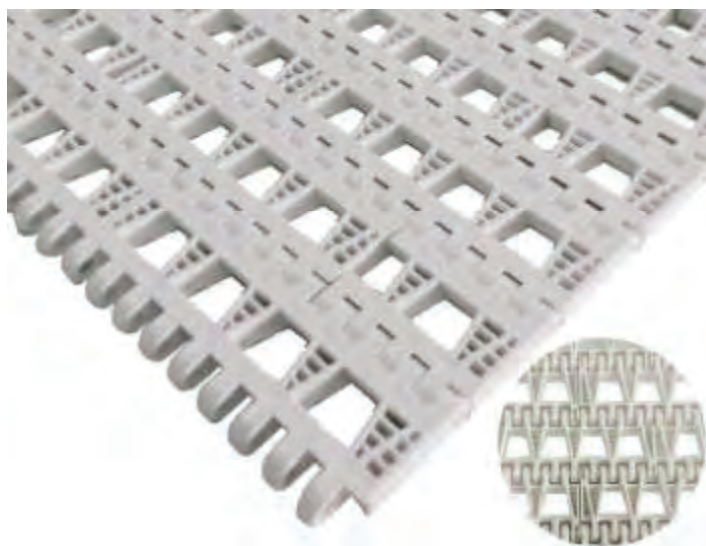

Belt Width=152.4+50.8 mm * N

| | | | | | | | | | |
|--------|--------|------|--------|--------|--------|--------|------|--------|--------|
| 152.4 | 203.2 | 254 | 304.8 | 355.6 | 406.4 | 457.2 | 508 | 558.8 | 609.6 |
| 660.4 | 711.2 | 762 | 812.8 | 863.6 | 914.4 | 965.2 | 1016 | 1066.8 | 1117.6 |
| 1168.4 | 1219.2 | 1270 | 1320.8 | 1371.6 | 1422.4 | 1473.2 | 1524 | 1574.8 | 1625.6 |
| 1676.4 | 1727.2 | 1778 | 1828.8 | 1879.6 | 1930.4 | 1981.2 | 2032 | 2082.8 | 2133.6 |

Sprocket

| | |
|------------------|----------|
| Tooth Z | 10 |
| Bore S | 50.0 mm |
| Diameter Ø | 161.4 mm |
| Tooth width d | 15.0 mm |
| Sprocket width D | 40.0 mm |
| Material | POM |
| Color | White |

Application

Food, poultry and other industrial that handle small-medium size products

Type: Flat top plastic modular

Code : FT5080-04

| Specification | |
|---------------------------|-----------------------|
| Pitch P | 50.8 mm |
| Thickness T | 16.0 mm |
| Pin Dia. D | 8.4 mm |
| Weight | 8.9 kg/m ² |
| Material | PP |
| Color | White / Blue |
| Open area | - |
| Permissible tensile force | 22000 N/m |
| Pin material | PP(PA) |
| Counter flection | 45.0 mm |
| Running radius | - |
| Characteristic | FDA |
| Temperature | 0~104 °C |

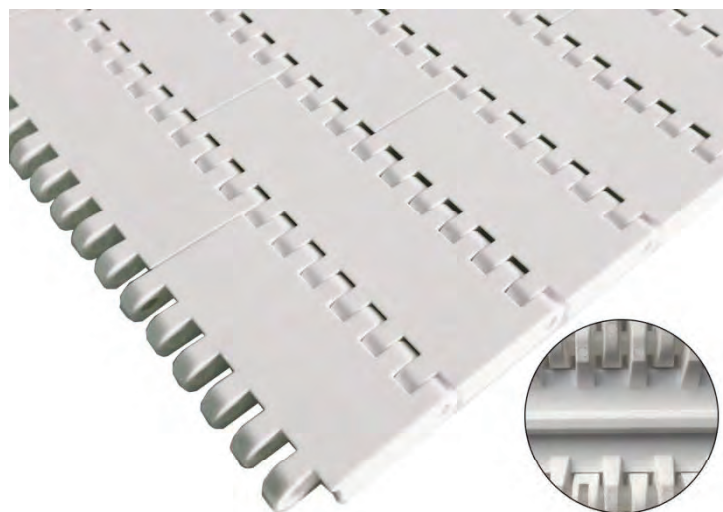

Belt Width=152.4+50.8 mm * N

| | | | | | | | | | |
|--------|--------|------|--------|--------|--------|--------|------|--------|--------|
| 152.4 | 203.2 | 254 | 304.8 | 355.6 | 406.4 | 457.2 | 508 | 558.8 | 609.6 |
| 660.4 | 711.2 | 762 | 812.8 | 863.6 | 914.4 | 965.2 | 1016 | 1066.8 | 1117.6 |
| 1168.4 | 1219.2 | 1270 | 1320.8 | 1371.6 | 1422.4 | 1473.2 | 1524 | 1574.8 | 1625.6 |
| 1676.4 | 1727.2 | 1778 | 1828.8 | 1879.6 | 1930.4 | 1981.2 | 2032 | 2082.8 | 2133.6 |

Sprocket

| | |
|------------------|---------|
| Tooth Z | 10 |
| Bore S | 50.0 mm |
| Diameter Ø | 154.6mm |
| Tooth width d | 30.0 mm |
| Sprocket width D | 38.0 mm |
| Material | POM |
| Color | Natural |

Application

Food, poultry and other industrial that handle small-medium size products

Type: Flush grid plastic modular

Code : FG5080-04

| Specification | |
|---------------------------|-----------------------|
| Pitch P | 50.8 mm |
| Thickness T | 16.0 mm |
| Pin Dia. D | 8.4 mm |
| Weight | 8.6 kg/m ² |
| Material | PP |
| Color | White / Blue |
| Open area | 18% |
| Permissible tensile force | 22000 N/m |
| Pin material | PP(PA) |
| Counter flection | 45.0 mm |
| Running radius | - |
| Characteristic | FDA |
| Temperature | 0~104 °C |



Belt Width=152.4+50.8 mm * N

| | | | | | | | | | |
|--------|--------|------|--------|--------|--------|--------|------|--------|--------|
| 152.4 | 203.2 | 254 | 304.8 | 355.6 | 406.4 | 457.2 | 508 | 558.8 | 609.6 |
| 660.4 | 711.2 | 762 | 812.8 | 863.6 | 914.4 | 965.2 | 1016 | 1066.8 | 1117.6 |
| 1168.4 | 1219.2 | 1270 | 1320.8 | 1371.6 | 1422.4 | 1473.2 | 1524 | 1574.8 | 1625.6 |
| 1676.4 | 1727.2 | 1778 | 1828.8 | 1879.6 | 1930.4 | 1981.2 | 2032 | 2082.8 | 2133.6 |

Sprocket

| | |
|------------------|----------|
| Tooth Z | 10 |
| Bore S | 50.0 mm |
| Diameter Ø | 154.6 mm |
| Tooth width d | 30.0 mm |
| Sprocket width D | 38.0 mm |
| Material | POM |
| Color | Natural |

Application

Food, poultry and other industrial that handle small-medium size products

Components

| | | | |
|--|---|--|--|
|  |  |  |  |
| Type: C101 Page: 71 | Type: C102 Page: 71 | Type: C103 Page: 71 | Type: C104 Page: 71 |
|  |  |  |  |
| Type: C105 Page: 71 | Type: C106 Page: 72 | Type: C107 Page: 72 | Type: C108 Page: 72 |
|  |  |  |  |
| Type: C109 Page: 72 | Type: C110 Page: 72 | Type: C111 Page: 73 | Type: C112 Page: 73 |
|  |  |  | |
| Type: C113 Page: 73 | Type: C114 Page: 73 | Type: C115 Page: 73 | |

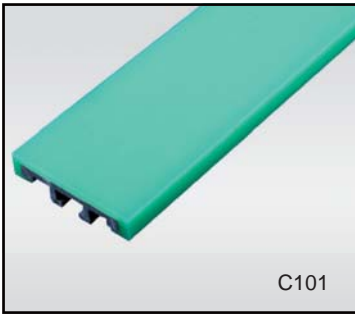

C101

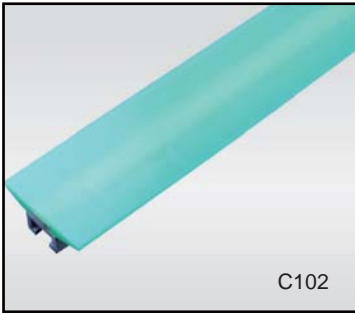
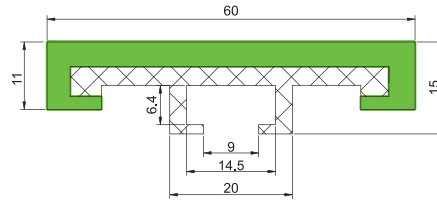

C102

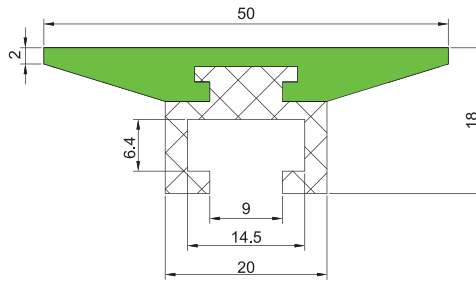

C103

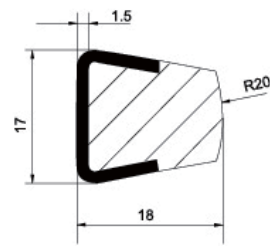

C104

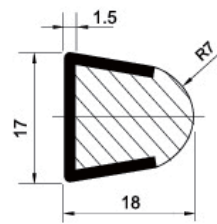

C105

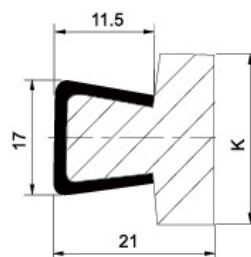



C106

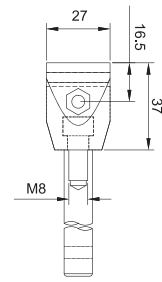
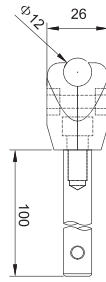

C107

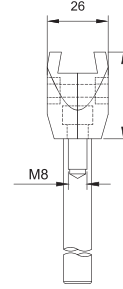
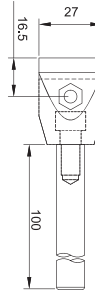

C108

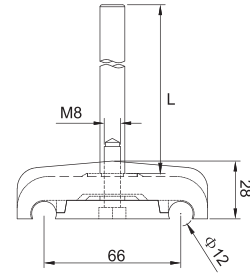
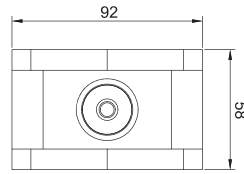

C109

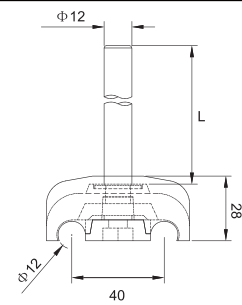
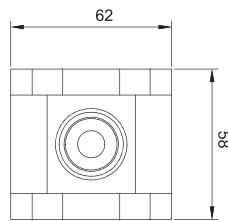



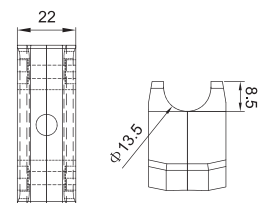
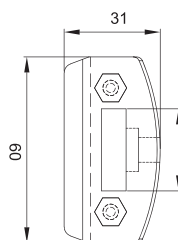

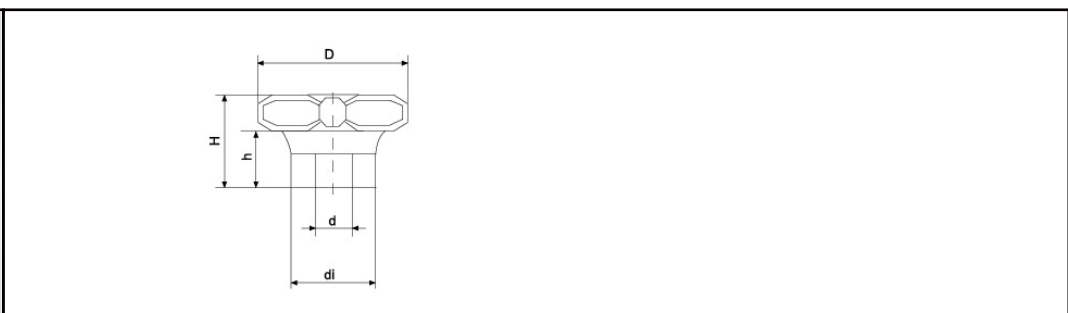
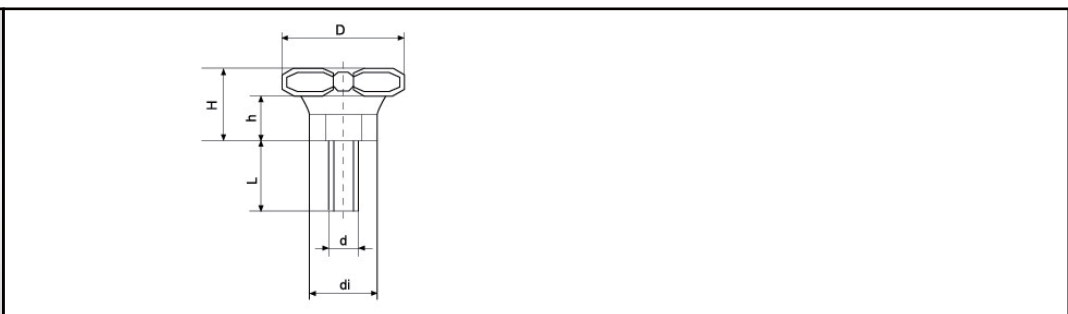
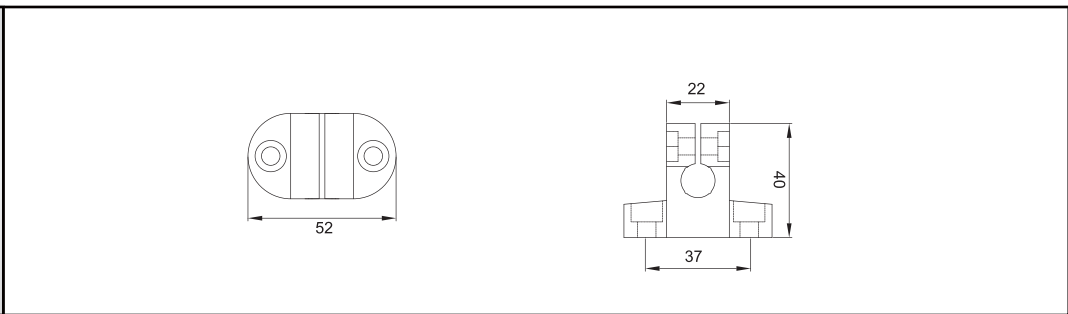
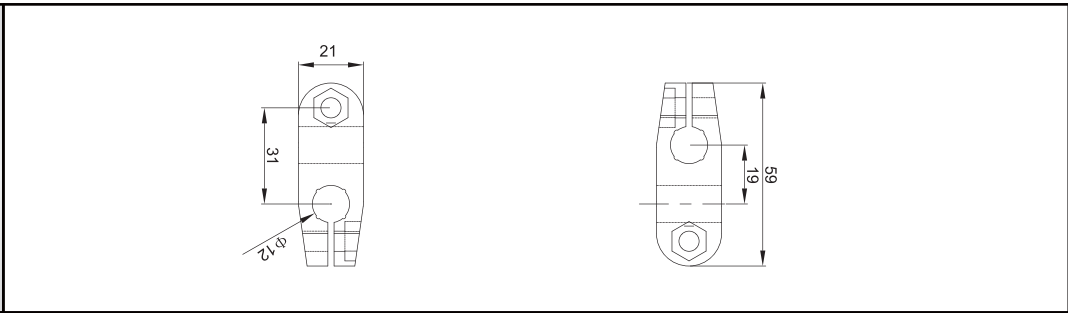
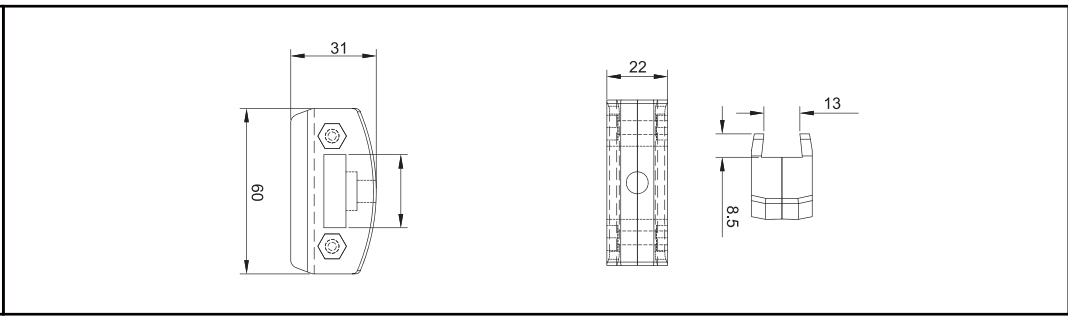
C110



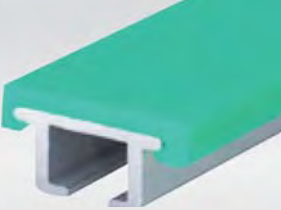
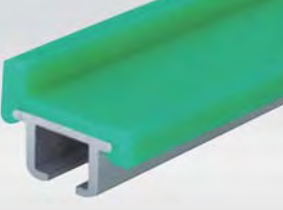
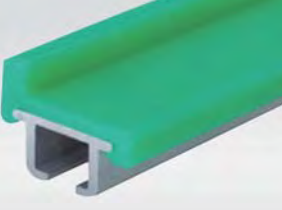

Components

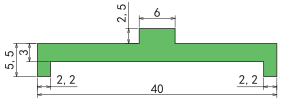
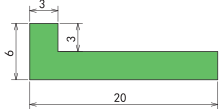
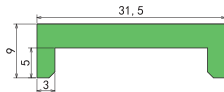
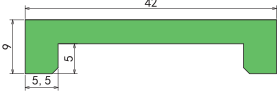
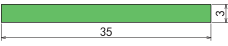
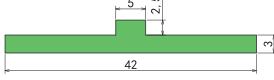
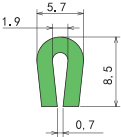
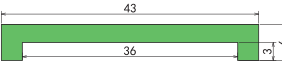
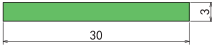
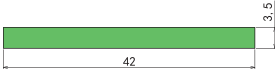
| | | | |
|---|--|---|--|
|  |  |  |  |
| <p>Type: C201 Page: 76</p> | <p>Type: C202 Page: 76</p> | <p>Type: C203 Page: 76</p> | <p>Type: C204 Page: 76</p> |
|  |  |  | |
| <p>Type: C205 Page: 76</p> | <p>Type: C206 Page: 77</p> | <p>Type: C207 Page: 77</p> | |
|  <p>D1</p> |  <p>D2</p> |  <p>D3</p> |  <p>D4</p> |
|  <p>D5</p> |  <p>D6</p> |  <p>D7</p> |  <p>D8</p> |
|  <p>D9</p> |  <p>D10</p> |  <p>D11</p> |  <p>D12</p> |

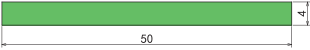
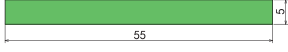
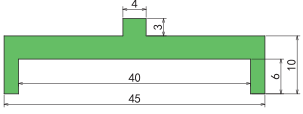
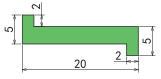
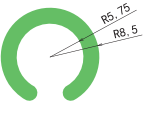
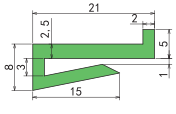
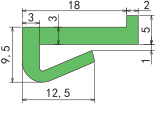
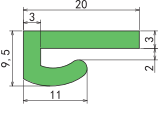
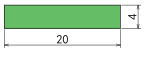
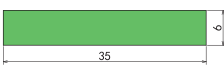
| | | | |
|--|--|---|--|
|  <p>D13</p> |  <p>D14</p> |  <p>D15</p> |  <p>D16</p> |
|  <p>D17</p> |  <p>D18</p> |  <p>D19</p> |  <p>D20</p> |
|  <p>D21</p> |  <p>D22</p> | | |

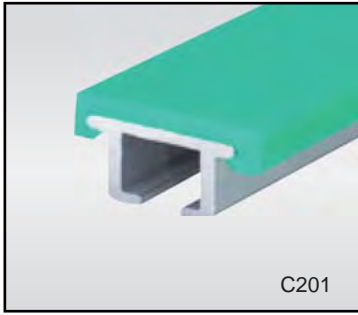

C201

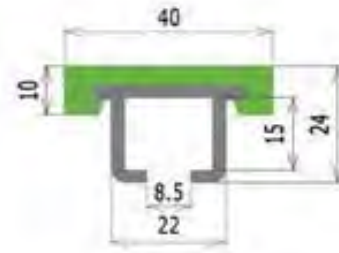

Aluminum

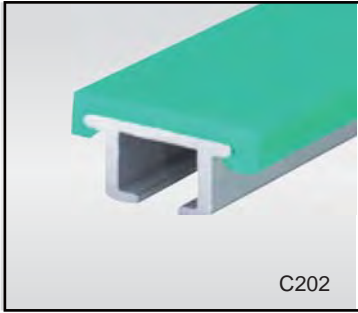

C202

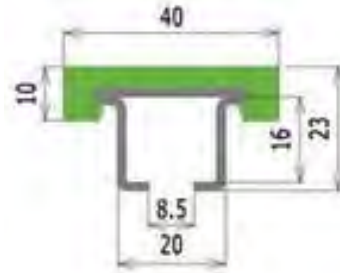

Stainless steel

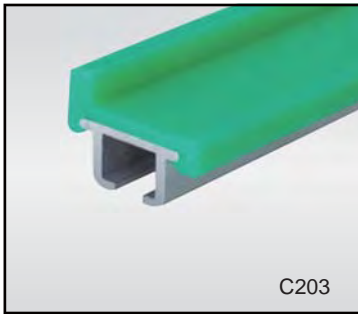

C203

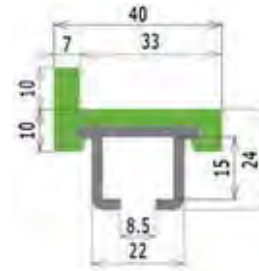

Aluminum

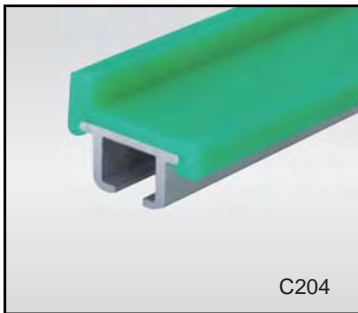

C204

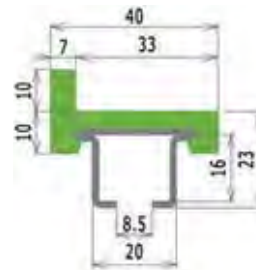

Stainless steel



C205

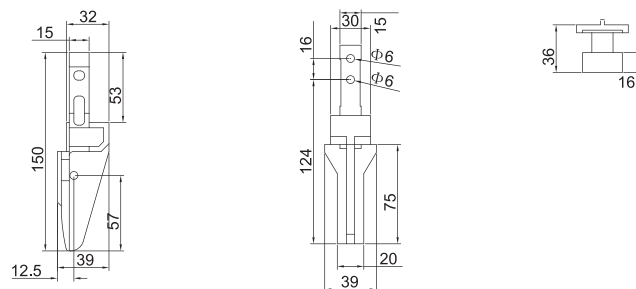

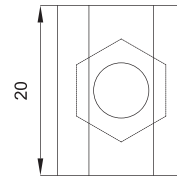
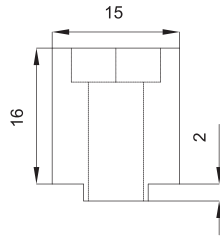
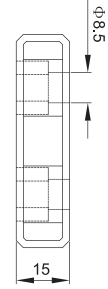
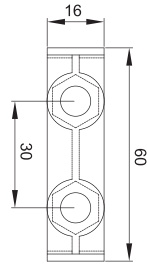
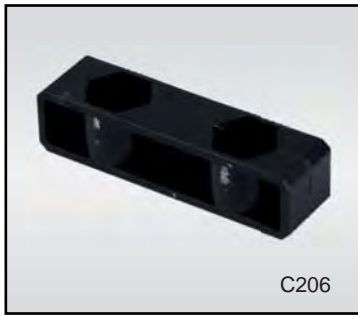

Components

| | | | |
|---|---|--|---|
|  |  |  |  |
| Type: C301 Page: 79 | Type: C302 Page: 79 | Type: C303 Page: 79 | Type: C304 Page: 79 |
|  |  |  |  |
| Type: C305 Page: 79 | Type: C306 Page: 80 | Type: C307 Page: 80 | Type: C308 Page: 80 |

Components

| | | | |
|---|---|--|---|
|  |  |  |  |
| Type: C401 Page: 81 | Type: C402 Page: 81 | Type: C403 Page: 81 | Type: C404 Page: 81 |
|  |  | | |
| Type: C405 Page: 81 | Type: C406 Page: 82 | | |

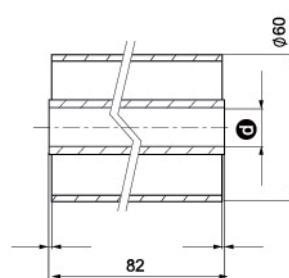
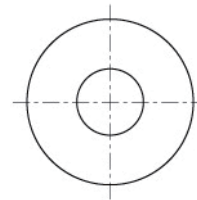
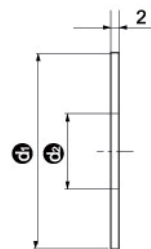
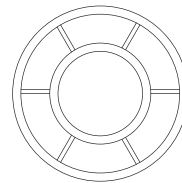
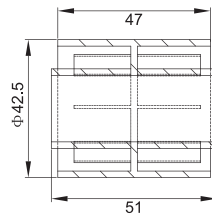
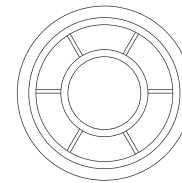
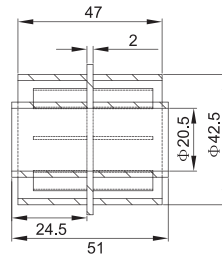
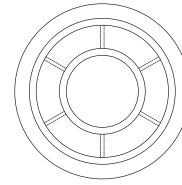
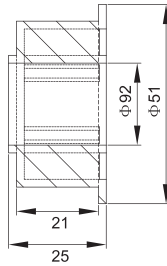

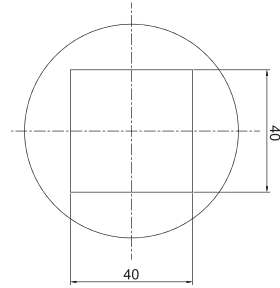
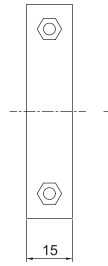
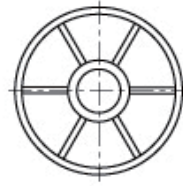
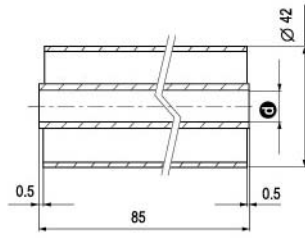
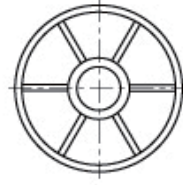
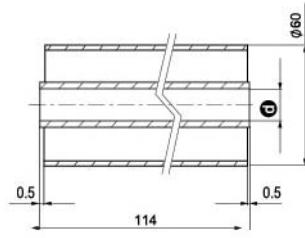



C401

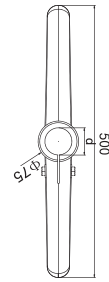
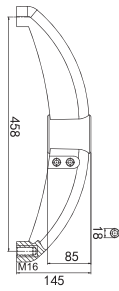

D=Φ48.3-63.5



C402

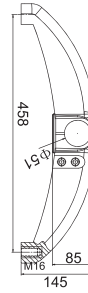
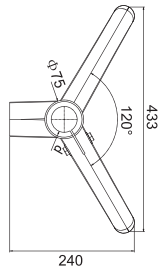

D=Φ48.3-63.5



C403

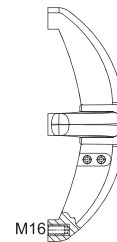
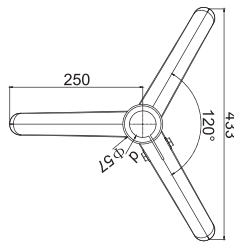

D=Φ48.3-63.5



C404

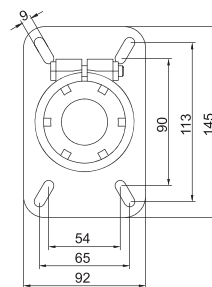
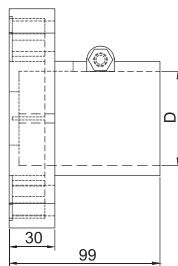

D=Φ42-63.5



C405

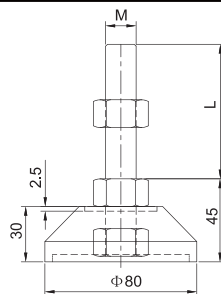



C406

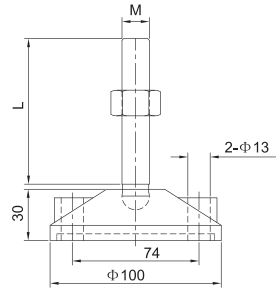

Components

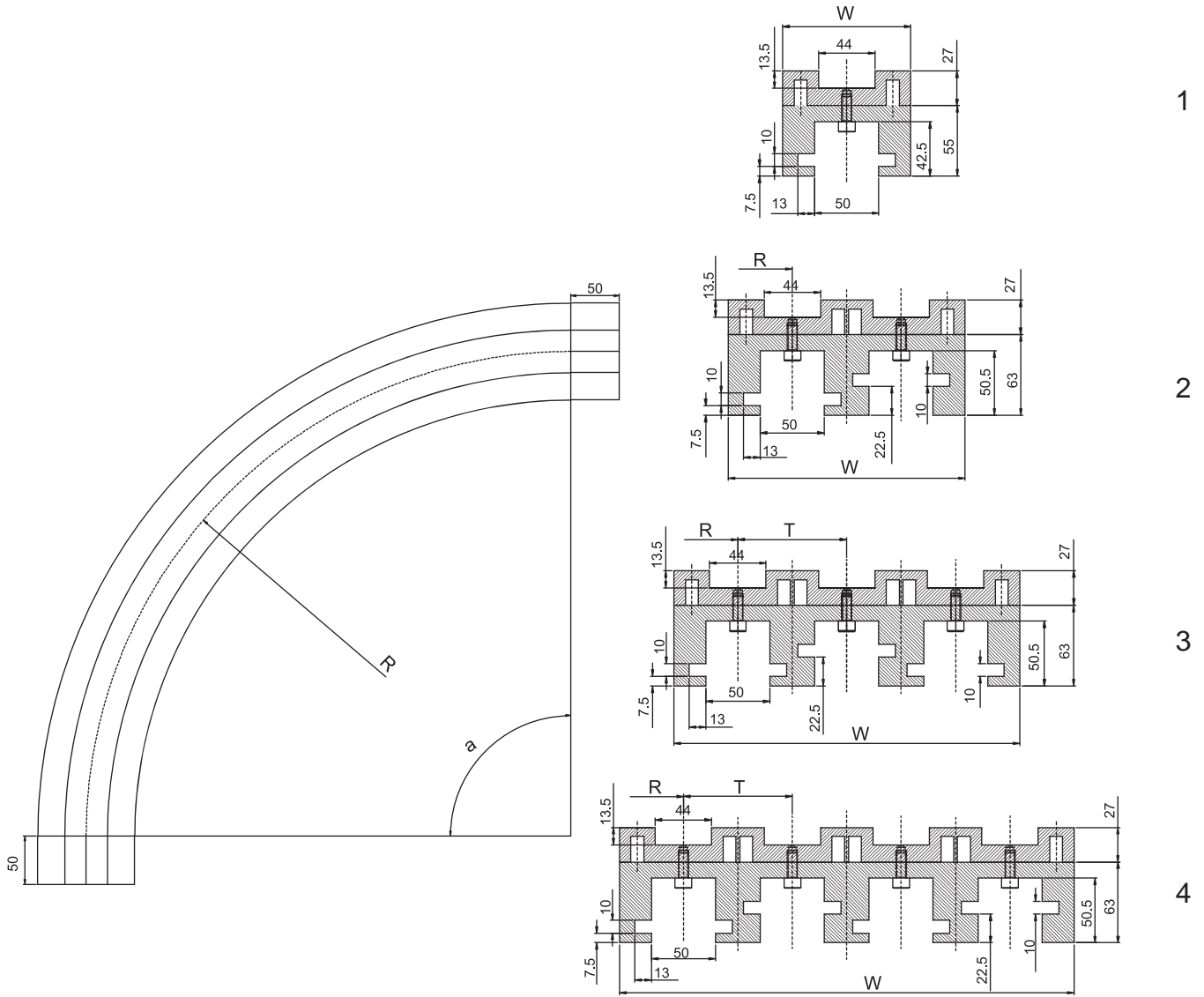

| Type | R | W | T |
|----------------------------|-----|-----|----|
| FTM2540TAB-K326-R500-100-1 | 500 | 100 | |
| FTM2540TAB-K326-R500-185-2 | 500 | 185 | 85 |
| FTM2540TAB-K326-R500-270-3 | 500 | 270 | 85 |
| FTM2540TAB-K326-R500-355-4 | 500 | 355 | 85 |

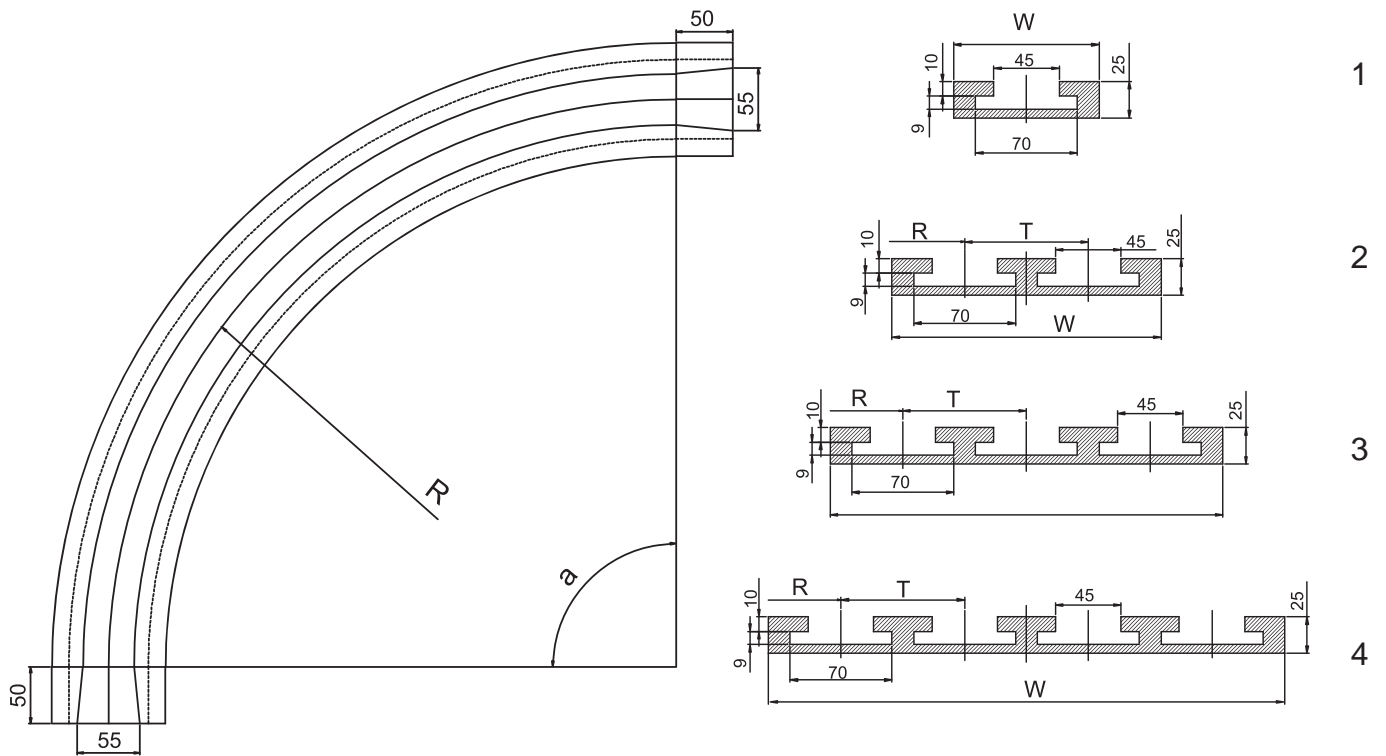

| Type | R | W | T |
|------------------------|-----|-----|-----|
| 880TAB-K325-R500-100-1 | 500 | 100 | |
| 880TAB-K325-R500-185-2 | 500 | 185 | 85 |
| 880TAB-K325-R500-270-3 | 500 | 270 | 85 |
| 880TAB-K325-R500-355-4 | 500 | 355 | 85 |
| 880TAB-K450-R610-130-1 | 610 | 130 | |
| 880TAB-K325-R610-250-2 | 610 | 250 | 120 |
| 880TAB-K450-R610-370-3 | 610 | 370 | 120 |
| 880TAB-K325-R610-490-4 | 610 | 490 | 120 |



HEAD OFFICE

SHANGHAI YONGLI BELTING CO.,LTD.
ADDRESS: NO. 58 XUWANG ROAD, XUJING TOWN,
QINGPU DISTRICT, SHANGHAI, CHINA
TEL: 0086-21-59884359 FAX: 0086-21-59884382
WEBSITE: www.yonglibelt.com
EMAIL: info@yonglibelt.com

BRANCHES

YONGLI EUROPE
Koolmand 3, 1724 BC
Oudkarspel, The Netherlands

YONGLI POLAND
Ul. Wojska Polskiego 889
-650 Czersk, Poland

YONGLI AMERICA
6625 Daniel Burnham Dr., Suite A,
Portage, IN 46368, USA

YONGLI GERMANY
Veldweg 35a, 6075NL
Herkenbosch, The Netherlands

YONGLI KOREA
29 Dangjaebong-ro, Paju-si,
Gyeonggi-do, Korea

YONGLI AUSTRIA
Bayernstrasse 815071
Wals-Siezenheim, Austria

YONGLI INDONESIA
Jl. Danau Sunter Barat Blok A2
no 4. Jakarta 14350, Indonesia